

ZAHNMEDIZIN DENTISTRY

2023/24

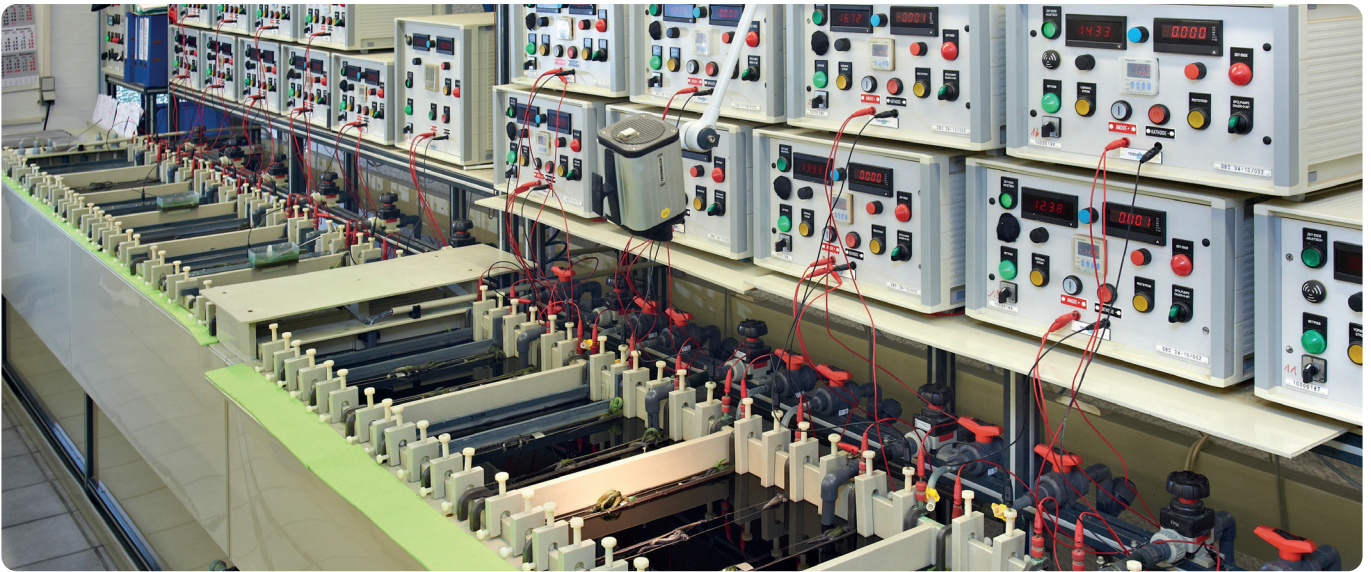



DFS DIAMON: Seit über 40 Jahren erfolgreich in Entwicklung, Produktion und Vertrieb zahnmedizinischer und zahn-technischer Erzeugnisse.

DFS DIAMON: excellence in product development, manufacturing and distribution of dentalmedical products for over 40 years.



Inhaltsverzeichnis / Content

	Seite / page	Seite / page	
EN ISO Norm / EN ISO code	4	ENDO Instrumente / Endodontic instruments	56
Diamantwerkzeuge / Diamond tools	5-43	Zirkoninstrumente / Zirconia tools	57-59
FG Diamanten / FG diamonds	6-33	Circopol N	57
FG Diamanten minimal invasiv	23	Trepanierer Zirkon / Trepanation instrument zirconia	57
FG Diamanten kurz / FG diamonds short shank	24-26	FG Diamanten Zirkon / FG diamonds for zirconia	58
FG Diamanten lang / FG diamonds long shank	27	Kronentrenner Zirkon / Crown cutter zirconia	59
FG Diamanten für ältere Patienten / FG diamonds for senior patients	27	Zircut® Kronentrenner / Zircut® Crown cutter	59
Diamanten WST / CA diamonds	28-29	Kronentrenner SOFTY-longlife / Crown Cutters SOFTY-longlife	60
Turbo Laser	30	Wunderkugel / Wonder Ball	60
Turbo Comp	31	Hartmetallinstrumente / Carbide burs	61-69
Redux	32	Hartmetallinstrumente / Carbide burs	61-65
Tiefenmarkierer / Depth markers	33	Finierer / Finishing burs	65-67
FG Piranhas	34-38	Kronentrenner / Crown cutters	68-69
Präparations-Sets / Preparation kits	39-43	KFO-Entferner / Orthodontic carbide bur	69
Diafutur®	39-40	Perio Diamanten / Perio diamonds	70
Kits	41-43	Reduzierstücke und Mandrelle / Reducers and mandrels	70
Polierer / Polishers	44-49	Mini-Flex	71
RTS	44-46	Gewebebestanzen / Tissue punches	71
Ultra-Light	45	PreciCut® Soft Tissue Trimmer	72
Uporal®	45	Orangenreiniger / Cleanorange	73
Diafix® Oral	45	Spiegelgriffe / Mirror handles	73
Prophylaxe Polierer	47	Oraler Scanspray / Scanspray for interoral use	74
2ceram Keramikpolierer / 2ceram polishers for ceramics	48	Erläuterung der Piktogramme / Explanation of pictograms	75
2metal Polierer / 2metal polishers	48	Allgemeine Anwendungs- und Sicherheitshinweises / General application and safety information	76
2comp Kompositpolierer / 2comp polishers for composites	49	Index	77
Durocomp Kompositpolierer / Durocomp polishers for composites	49		
Bohrerstände / Trays	47		
Handyfix	47		
Chirurgie / Surgery	50-56		
Stahlinstrumente / Steel surgical burs	50-51		
Hartmetallinstrumente / Surgical burs carbide	52-55		
Diadoss Fräser / Diadoss Cutters	56		

Die Standardisierung von Werkzeugen nach der ISO-Norm 6360

The standardisation of tools according to ISO standard 6360

Von der Internationalen Standardisierungsorganisation (ISO) wurde eine Reihe von Konventionen hinsichtlich der Bezeichnung von rotierenden Werkzeugen in der Dentaltechnik eingeführt. Jedes Werkzeug wird mit einem international eindeutigen **ISO-Nummerncode** gekennzeichnet, der aus 15 Ziffern in 5 Gruppen besteht und gleichzeitig die **Beschreibung der Werkzeugeigenschaften** beinhaltet.

*In order to achieve conformity the International Organization for standardization (ISO) has defined a standard description of rotary instruments used in the dental industry. Each instrument is assigned a distinct **ISO number code** which is made up of 15 digits in 5 subgroups and simultaneously contains **the specification for each instrument**.*

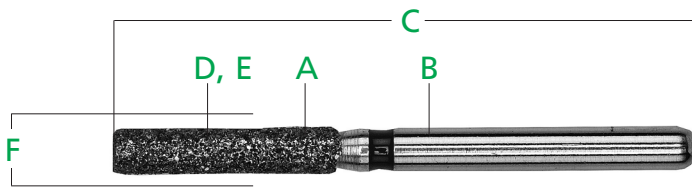

ISO-Nr.	806	314	112	524	016
	A	B,C	D	E	F

- A Werkstoff des Arbeitsteils, z.B. 806 (galvanische Diamanten)
Material of the working part, e.g. 806 (electroplated diamonds)
- B,C Schaft und Gesamtlänge, z.B. 314 für FG
Shank and total length e.g. 314 for FG
- D Form und Ausführung z.B. 112 für eine zylindrische Form
Shape, e.g. 112 for a cylindrical shape
- E Körnung, z.B. 524 für mittlere Körnung
Particle Size, e.g. 524 for medium / standard grit
- F Nenngröße, größter Durchmesser des Arbeitsteils in 0,1 mm
Size, largest diameter of the working part in 0,1 mm

ISO Farbcode / ISO color code

----- Arbeitsablauf (Diamanten) / sequence (diamonds) ----->

extragrob/extracoarse
schwarz/black



grob/coarse
grün/green

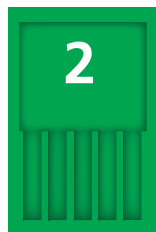

mittel/medium
blau/blue



fein/fine
rot/red



superfein/superfine
gelb/yellow

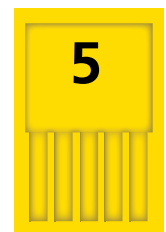

- ✓ **Hinweis:**
Es sollte nicht mehr als eine Farbe übersprungen werden; z.B. 1 auf 3 ist möglich, 1 auf 5 ist nicht empfehlenswert, da zu hoher Material- oder Zeitaufwand.

Note:
No more than one step should be omitted. For example moving from coarse to fine is ok, but switching from coarse to superfine will result in inefficient use of time and/or material.

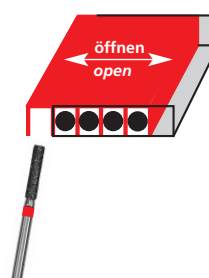

Die praktische Schiebeverpackung für die Entnahme der einzelnen Werkzeuge.

Instruments can be easily accessed by sliding the lid of the packaging.

FG Diamanten – Ihre Vorteile

FG diamonds – your benefits

Die 2-Lagen diamantierten FGs haben bis zu 70% höhere Standzeit als herkömmliche FGs.
The two-layer diamond coated FGs last about 70% longer than conventional one-layer FG diamonds.

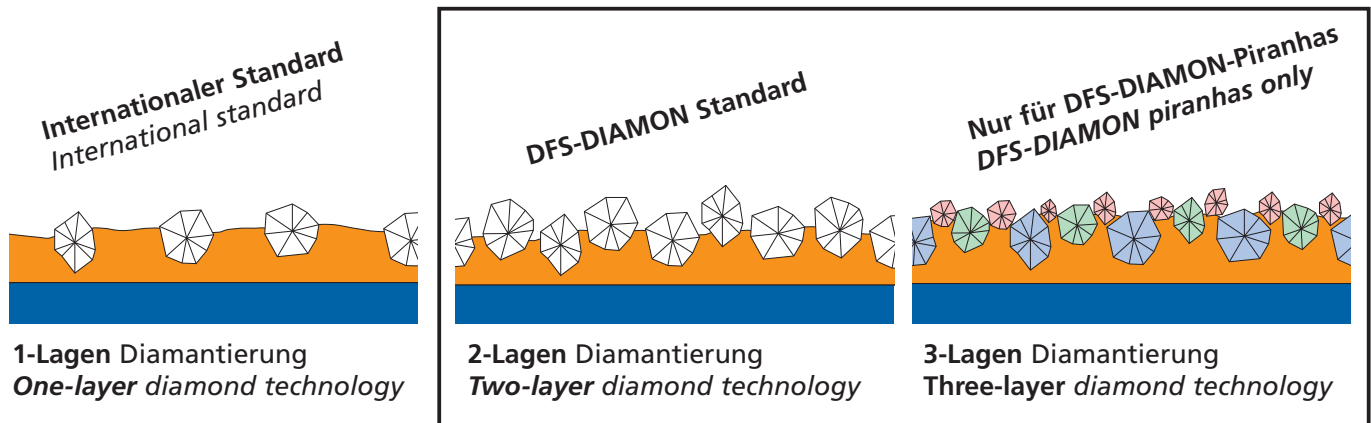

- ✓ Ausgezeichnete Qualität
Excellent quality
- ✓ Made in Germany
- ✓ Fertigung nach MDD93/42/EEC - CMDR 2017/745 gültig ab Zertifizierung - Ihre Sicherheit für höchste Qualität
Manufactured according to MDD93/42/EEC - CMDR 2017/745 applicable with certification - your assurance for highest quality
- ✓ Unser QM-System ist zertifiziert nach DIN EN ISO 13485
Our quality management system is certified according to DIN EN ISO 13485
- ✓ Farbcodiert für optimale Effizienz
Color coded for optimal efficiency
- ✓ Um beste und schnellste Ergebnisse zu erzielen empfehlen wir, die Instrumente in der Reihenfolge der Farbcodierung einzusetzen: von dunkel nach hell oder 1 bis 5.
For best results we recommend using the instruments in sequence following the color code: from dark to light or 1 to 5.
- ✓ Der Farbring am Instrument und die Farbe der Verpackung entsprechen dem ISO Code.
The color ring on the instrument shank and the color of the packaging correspond to the ISO code.

Anwendungssymbole / Usage symbols



FG Diamanten – Royal line in 2-Lagen Diamantierung

FG diamonds – Royal line with two-layer diamond technology

ISO Nr.: 806 314 F 504 superfein / superfine

806 314 F 514 fein / fine

806 314 F 524 mittel / medium

806 314 F 534 grob / coarse

806 314 F 544 extragroß / extracoarse

Drehzahl / speed

30' - 300000 Upm / rpm

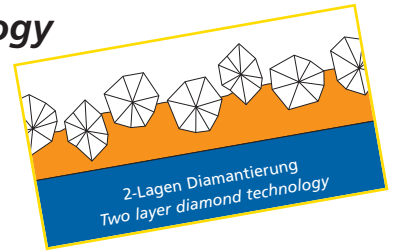

801	F:	001	001	001	001	001	001	001	001	001	001	001	001
	d:	008	009	010	012	014	016	018	021	023	025	027	029
	KL/hl:	-	-	-	-	-	-	-	-	-	-	-	-
	P:	1	1	1	1	1	1	1	2	2	2	3	3

530066	530076	530014
530068	530078	530016
530065	530075	530018
535238	530073	530015
535235	530077	530013
530026	530024	530026
530028	530034	530028
530025	530036	530025
530023	530038	530022
530033	530046	530035
530043	530048	530033
530045	530054	530045
530053	530056	530053
530055	530058	530055
530243	530248	530243
530245	530246	530245
530247	530249	530247
530368	530284	530368
530365	530286	530365
530283	530288	530283
530285	530254	530285
530253	530256	530253
530003	530008	530003
530005	530006	530005

802	F:	002	002	002	002	002	002	002	002
	d:	008	009	010	012	014	016	018	023
	KL/hl:	2,5	2,5	2,5	3	3	3	3,5	4,5
	P:	1	1	1	1	1	1	1	2

530278	530086
535648	530088
530298	530316
530295	530085
530085	530318
530315	530338
530313	530335
530333	530098
530093	530095
536238	535968

805	F:	010	010	010	010	010	010	010	010	805	F:	014	014	
	d:	009	010	012	014	016	018	021	022	023		d:	018	023
	KL/hl:	1	1	1,5	1,5	1,5	1,6	2	2	2		KL/hl:	0,7	1
	P:	1	1	1	1	1	1	2	2	2		P:	1	2

530178	530166
530168	530108
530165	530118
530105	530115
530113	530128
530123	530136
530135	530138
530133	530135
530198	530198
530148	530148
530188	530188
530378	530378
530388	530388

Alle Royal Line FG Diamanten sind zu 5 Stück verpackt.
 F = ISO-Figur-Nr. · KL = Kopflänge in mm
 d = Durchmesser in 1/10 mm · P = Preiskategorie

All royal line FG diamonds are packed as 5 pieces.
 F = ISO-Shape-No. · hl = head length in mm
 d = diameter in 1/10 mm · P = price category

FG Diamanten – Royal line in 2-Lagen Diamantierung

FG diamonds – Royal line with two-layer diamond technology

ISO Nr.: 806 314 F 504 superfein / superfine
 806 314 F 514 fein / fine
 806 314 F 524 mittel / medium
 806 314 F 534 grob / coarse
 806 314 F 544 extragrob / extracoarse

Drehzahl / speed
 30' - 300000 Upm / rpm

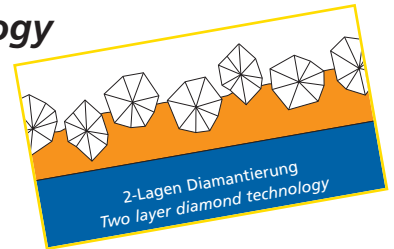

		F :	019	019	019	019	019	019
		d :	010	012	014	016	018	023
		KL/hl :	2,2	3	3	3	3,2	4
		P :	1	1	1	1	1	2

		F :	032	032	032
		d :	010	014	016
		KL/hl :	1,4	1,6	1,8
		P :	1	1	1

		F :	033	033	033
		d :	021	027	031
		KL/hl :	6,5	7	7
		P :	2	2	3

		F :	038	038
		d :	031	033
		KL/hl :	4,5	4,5
		P :	3	3

		F :	039	039	039	039	039
		d :	033	037	040	045	047
		KL/hl :	4,5	7	7	7	7
		P :	3	3	3	3	3

		F :	039	039	039	039	039
		d :	033	037	040	045	047
		KL/hl :	4,5	7	7	7	7
		P :	3	3	3	3	3

		F :	038	038
		d :	031	033
		KL/hl :	4,5	4,5
		P :	3	3

Alle Royal Line FG Diamanten sind zu 5 Stück verpackt.
 F = ISO-Figur-Nr. · KL = Kopflänge in mm
 d = Durchmesser in 1/10 mm · P = Preiskategorie

All royal line FG diamonds are packed as 5 pieces.
 F = ISO-Shape-No. · hl = head length in mm
 d = diameter in 1/10 mm · P = price category

FG Diamanten – Royal line in 2-Lagen Diamantierung

FG diamonds – Royal line with two-layer diamond technology

ISO Nr.: 806 314 F 504 superfein / superfine

806 314 F 514 fein / fine

806 314 F 524 mittel / medium

806 314 F 534 grob / coarse

806 314 F 544 extragroß / extracoarse

Drehzahl / speed

30' - 300000 Upm / rpm

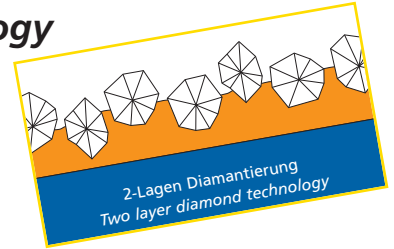

818	F:	040	040	040	040	040	040	040	040
	d:	012	016	023	027	033	040	042	050
	KL/hl:	0,4	0,5	0,9	1	1	1	1	1
	P:	1	1	2	2	3	3	3	3

820	F:	042	042
	d:	040	050
	KL/hl:	2	2
	P:	3	3

536818
536815

536738

536088

530965

536408

536428
536425

536418
536415

535988

530985

530998

909	F:	067
	d:	035
	KL/hl:	0,6
	P:	3

909	F:	068	068	068	068	068	068
	d:	027	032	037	040	042	055
	KL/hl:	1	1	1	1	1	2
	P:	3	3	3	3	3	3

531178

532708

532726
532728

532725

532718

532715

532788

532738

532783

532735

531188

909	F:	069	069	069
	d:	042	050	055
	KL/hl:	2,3	3,0	3,6
	P:	3	3	3

835	F:	108	108
	d:	008	009
	KL/hl:	3	3
	P:	1	1

532768
532765

535818

532748

530604

530608

530605

535518

535515

Alle Royal Line FG Diamanten sind zu 5 Stück verpackt.
F = ISO-Figur-Nr. · KL = Kopflänge in mm
d = Durchmesser in 1/10 mm · P = Preiskategorie

All royal line FG diamonds are packed as 5 pieces.
F = ISO-Shape-No. · hl = head length in mm
d = diameter in 1/10 mm · P = price category

FG Diamanten – Royal line in 2-Lagen Diamantierung

FG diamonds – Royal line with two-layer diamond technology

ISO Nr.: 806 314 F 504 superfein / superfine

806 314 F 514 fein / fine

806 314 F 524 mittel / medium

806 314 F 534 grob / coarse

806 314 F 544 extragroß / extracoarse

Drehzahl / speed

30' - 300000 Upm / rpm

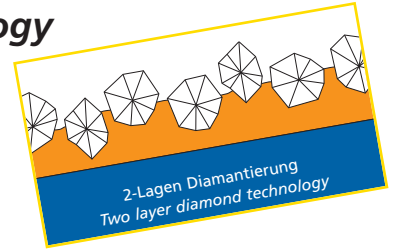

	F : d : KL/hl : P :				
		109	109	109	109
		010	012	014	016
		4	4	4	4
		1	1	1	1

	F : d : KL/hl : P :						
		110	110	110	110	110	110
		008	010	012	014	016	018
		6	6	6	6	6	6
		1	1	1	1	1	1

	F : d : KL/hl : P :						
		111	111	111	111	111	111
		010	012	014	016	018	018
		8	8	8	8	8	8
		1	1	1	1	1	1

	F : d : KL/hl : P :						
		112	112	112	112	112	112
		010	012	014	016	018	018
		10	10	10	10	10	10
		1	1	1	1	1	1

	F : d : KL/hl : P :		
		129	129
		012	012
		6	6
		1	1

	F : d : KL/hl : P :					
		130	130	130	130	130
		010	012	014	016	018
		8	8	8	8	8
		1	1	1	1	1

530616
530618
530615
530613
530626
530628
530625
530623
530636
530638
530635
530633
535678
535675
535673

531284
531288
531258
531255
530646
530648
530645
530658
530655
530653
531268
531265
531278
531275

531336
531338
531335
531333
530756
530758
530755
530753
530686
530688
530676
530678
530675
530685

531368
531376
531375
531386
531388
531385
530698
530695
531398

536588
536585

532408
532405
532414
532416
532418
532415
532413
532428
532425
532485
532438
532435

Alle Royal Line FG Diamanten sind zu 5 Stück verpackt.
F = ISO-Figur-Nr. · KL = Kopflänge in mm
d = Durchmesser in 1/10 mm · P = Preiskategorie

All royal line FG diamonds are packed as 5 pieces.
F = ISO-Shape-No. · hl = head length in mm
d = diameter in 1/10 mm · P = price category

FG Diamanten – Royal line in 2-Lagen Diamantierung

FG diamonds – Royal line with two-layer diamond technology

ISO Nr.: 806 314 F 504 superfein / superfine

806 314 F 514 fein / fine

806 314 F 524 mittel / medium

806 314 F 534 grob / coarse

806 314 F 544 extragroß / extracoarse

Drehzahl / speed

30' - 300000 Upm / rpm

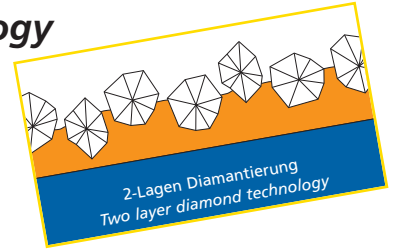

	F : d : KL/hl : P :	131	131	131
		012	014	016
		10	11	11
		1	1	1
		886		

	F : d : KL/hl : P :	137	137	137	137
		008	009	010	012
		3,5	3,2	4	4
		1	1	1	1
		838			

536626
536628
536625
536623
532498
532495
532493
532446
532448
532445
532443

536028
536468
535778
535775
535773
535825
535823

	F : d : KL/hl : P :	139	139	139
		008	010	014
		4,5	4,5	4,5
		1	1	1
		838		

	F : d : KL/hl : P :	140	140	140	140	140
		010	012	014	016	018
		6	6,5	6	6	6
		1	1	1	1	1
		880				

530944
530938
530948
530945
530958

532458
532455
532468
532465
532478
532475
532473
532474
532476
535918
535858

	F : d : KL/hl : P :	141	141	141	141	141
		010	012	014	016	018
		8,5	8,5	8,5	8,5	8,5
		1	1	1	1	1
		881				

	F : d : KL/hl : P :	142	142	142	142
		012	014	016	018
		10,5	10,5	10,5	10,5
		1	1	1	1
		882			

532556
532558
532555
532563
532564
532566
532568
532565
532574
532576
532578
532575
532573
532584
532586
532588
532585
532583
532654
532656
532658
532655
532653

532666
532668
532665
532678
532675
532695
532688
532685
532683

Alle Royal Line FG Diamanten sind zu 5 Stück verpackt.
F = ISO-Figur-Nr. · KL = Kopflänge in mm
d = Durchmesser in 1/10 mm · P = Preiskategorie

All royal line FG diamonds are packed as 5 pieces.
F = ISO-Shape-No. · hl = head length in mm
d = diameter in 1/10 mm · P = price category

FG Diamanten – Royal line in 2-Lagen Diamantierung

FG diamonds – Royal line with two-layer diamond technology

ISO Nr.: 806 314 F 504 superfein / superfine

806 314 F 514 fein / fine

806 314 F 524 mittel / medium







806 314 F 534 grob / coarse

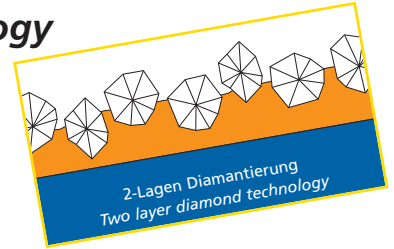





806 314 F 544 extragroß / extracoarse

Drehzahl / speed

30' - 300000 Upm / rpm



										
						F:	150	150	150	150
						d:	010	012	014	016
						KL/hl:	-	-	-	-
						P:	3	3	3	3

										
						F:	156	156	156	156
						d:	008	010	012	014
						KL/hl:	5	5	5	5
						P:	1	1	1	1



530708

530718

530728





530738

530768







530778

530788

530798

								
					F:	157	157	157
					d:	010	012	014
					KL/hl:	6,5	6,5	6,5
					P:	1	1	1



										
						F:	158	158	158	158
						d:	010	012	014	016
						KL/hl:	8	8	8	8
						P:	1	1	1	1



530838

530848

530858

530855

530868





530878





530886

530888

530885

533148

						
				F:	159	159
				d:	008	010
				KL/hl:	3	4
				P:	1	1

						
				F:	161	161
				d:	010	012
				KL/hl:	6	6
				P:	1	1

531454

531456

531444

531446

531476

531478

531304

531306

531308

531305

Alle Royal Line FG Diamanten sind zu 5 Stück verpackt.

F = ISO-Figur-Nr. · KL = Kopflänge in mm

d = Durchmesser in 1/10 mm · P = Preiskategorie

All royal line FG diamonds are packed as 5 pieces.

F = ISO-Shape-No. · hl = head length in mm

d = diameter in 1/10 mm · P = price category

FG Diamanten – Royal line in 2-Lagen Diamantierung

FG diamonds – Royal line with two-layer diamond technology

ISO Nr.: 806 314 F 504 superfein / superfine

806 314 F 514 fein / fine

806 314 F 524 mittel / medium

806 314 F 534 grob / coarse

806 314 F 544 extragroß / extracoarse

Drehzahl / speed

30' - 300000 Upm / rpm

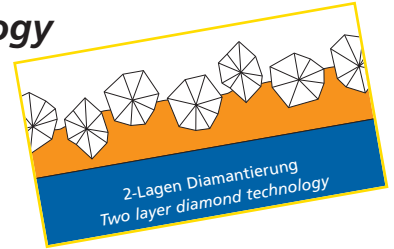

	F:	164	164	164	164	164
	d:	010	012	014	016	023
	KL/hl:	4	6	6	6	6
	P:	1	1	1	1	2

	F:	165	165	165	165	165
	d:	010	012	014	016	018
	KL/hl:	8	8	8	8	8
	P:	1	1	1	1	1

536564
536566
536568
536565
535584
535586
535588
535585
535583
531494
531496
535796
535798
536528
536525

531666
531668
531324
531326
531328
531325
531314
531316
531318
531315
531313
531674
531678
531675
533328
533325

	F:	166	166	166	166	166	166
	d:	010	012	014	016	018	021
	KL/hl:	10	10	10	10	10	10
	P:	1	1	1	1	1	2

	F:	167	167	167
	d:	010	012	018
	KL/hl:	11	11	11,5
	P:	1	1	1

535284
535286
535288
535285
535283
531874
531876
531878
531875
531873
531884
531886
531888
531885
531883
531894
531896
531898
531895
531893
531704
531706
531708
531705
531703
533805

530396
530398
532626
532628
531988
531985

	F:	170	170	170	170	170	170	170
	d:	009	010	012	014	016	018	021
	KL/hl:	4	4	4	4	4	4	4
	P:	1	1	1	1	1	1	2

532064
535838
535928
535925
532068
532065
532063
532078
532075
532073
530806
530808
530805
535468
535478

Alle Royal Line FG Diamanten sind zu 5 Stück verpackt.
F = ISO-Figur-Nr. · KL = Kopflänge in mm
d = Durchmesser in 1/10 mm · P = Preiskategorie

All royal line FG diamonds are packed as 5 pieces.
F = ISO-Shape-No. · hl = head length in mm
d = diameter in 1/10 mm · P = price category

FG Diamanten – Royal line in 2-Lagen Diamantierung

FG diamonds – Royal line with two-layer diamond technology

ISO Nr.: 806 314 F 504 superfein / superfine

806 314 F 514 fein / fine

806 314 F 524 mittel / medium

806 314 F 534 grob / coarse

806 314 F 544 extragroß / extracoarse

Drehzahl / speed

30' - 300000 Upm / rpm

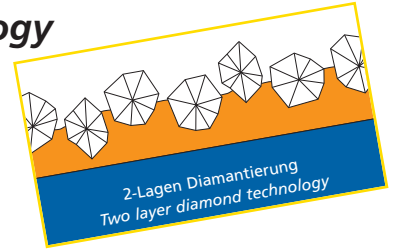

		F:	171	171	171	171	171
		d:	012	014	016	018	025
		KL/hl:	6	6	6	7	7
		P:	1	1	1	1	2
		846					

		F:	172	172	172	172	172	172
		d:	012	014	016	018	021	023
		KL/hl:	8	8	8	8	8	8
		P:	1	1	1	1	2	2
		847						

532188
532185
532183
532248
530816
530818
530815
530828
535526
535528
535525

530904
532278
532275
532273
530908
530905
530903
530916
530918
530915
530913
530928
530925
530923
535908
535905
535903
532285

		F:	173	173	173	173	173	173	
		d:	010	012	014	016	018	023	025
		KL/hl:	10	10	10	10	10	10	10
		P:	1	1	1	1	1	2	2
		848							

533248
533245
531004
531006
531008
531005
531003
531016
531018
531015
531013
531024
531026
531028
531025
531023
531038
531035
531033
533258
533255
535628

		F:	174	174	174	174
		d:	012	014	016	018
		KL/hl:	11,5	11,5	11,5	11,5
		P:	1	1	1	1
		848L				

		F:	183
		d:	025
		KL/hl:	7
		P:	2
		846L	

		F:	195	195
		d:	007	009
		KL/hl:	3	3
		P:	1	1
		957		

532636
532638
532635
531046
531048
531045
531043
531058
531055
531053
531068
531065
531063

532648

532954
532956
532964
532966

Alle Royal Line FG Diamanten sind zu 5 Stück verpackt.
F = ISO-Figur-Nr. · KL = Kopflänge in mm
d = Durchmesser in 1/10 mm · P = Preiskategorie

All royal line FG diamonds are packed as 5 pieces.
F = ISO-Shape-No. · hl = head length in mm
d = diameter in 1/10 mm · P = price category

FG Diamanten – Royal line in 2-Lagen Diamantierung

FG diamonds – Royal line with two-layer diamond technology

ISO Nr.: 806 314 F 504 superfein / superfine

806 314 F 514 fein / fine

806 314 F 524 mittel / medium



806 314 F 534 grob / coarse

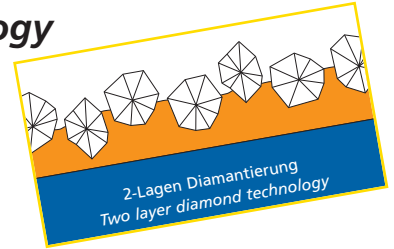

806 314 F 544 extragroß / extracoarse

Drehzahl / speed

30' - 30000 Upm / rpm







		F :	196	196	196
		d :	009	010	012
		KL/hl :	4	4	4
		P :	1	1	1
		849			

		F :	197	197	197
		d :	012	014	016
		KL/hl :	6	6	6
		P :	1	1	1
		855			

536484
536486
536488
536638
536635
536298
536295
536293



531406
531408
531405
531403
531416
531418
531415
531428

		F :	198	198	198	198	198	198	198	
		d :	010	012	014	016	018	021	023	025
		KL/hl :	8	8	8	8	8	8	8	8
		P :	1	1	1	1	1	2	2	2
		856								

		F :	198L	198L
		d :	012	023
		KL/hl :	9	9
		P :	1	2
		856L		

533118
533124
533126
533128
533125
533123
533108
533106
533104
533102
533100
533105
533103
531504
531506
531508
531505
531503
531514
531516
531518
531515
531513
531524
531526
531528
531525
531523
531584
531586
531588
531585
531583
531598
531595
531593

535148
535145
535138

		F :	199	199	199	199	199	199	199	
		d :	010	012	014	016	018	020	023	024
		KL/hl :	10	10	10	10	10	10	10	10
		P :	1	1	1	1	1	2	2	2
		850								

531104
531106
531108
531105
531114
531116
531118
531115
531113
531124
531126
531128
531125
531123
531134
531136
531138
531135
531133
531144
531146
531148
531145
531143
531195
535406
535408
535405
535403
535408C

Alle Royal Line FG Diamanten sind zu 5 Stück verpackt.
F = ISO-Figur-Nr. · KL = Kopflänge in mm
d = Durchmesser in 1/10 mm · P = Preiskategorie

All royal line FG diamonds are packed as 5 pieces.
F = ISO-Shape-No. · hl = head length in mm
d = diameter in 1/10 mm · P = price category

FG Diamanten – Royal line in 2-Lagen Diamantierung

FG diamonds – Royal line with two-layer diamond technology

ISO Nr.: 806 314 F 504 superfein / superfine

806 314 F 514 fein / fine

806 314 F 524 mittel / medium

806 314 F 534 grob / coarse

806 314 F 544 extragroß / extracoarse

Drehzahl / speed

30' - 300000 Upm / rpm

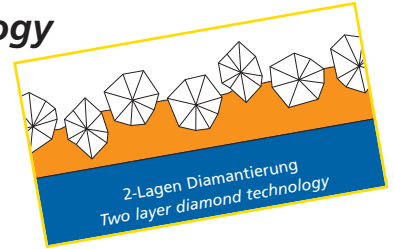

850L	F : 200	200	200	200
	d : 012	014	016	018
	KL/hl : 11,5	11,5	11,5	11,5
	P : 1	1	1	1

850L	F : 201	201	
	d : 014	018	
	KL/hl : 9	9	
	P : 1	1	

- 533228
- 533225
- 533238
- 533235
- 533233
- 531156
- 531158
- 531155
- 531153
- 531166
- 531168
- 531165
- 531163

- 533278
- 533275
- 533288
- 533285

879K	F : 213	
	d : 016	
	KL/hl : 10	
	P : 1	

851	F : 219	219	219	219	
	d : 012	014	016	018	
	KL/hl : 8	8	8	8	
	P : 1	1	1	1	

- 533368
- 533365

- 531206
- 531208
- 531205
- 536728
- 536725
- 531298
- 531295
- 533168

857	F : 220	220	220	
	d : 012	014	016	
	KL/hl : 10	10	10	
	P : 1	1	1	

869K	F : 222	
	d : 014	
	KL/hl : 6	
	P : 1	

868K	F : 223	223	
	d : 012	016	
	KL/hl : 8	8	
	P : 1	1	

- 531688
- 531685
- 531606
- 531608
- 531605
- 531698
- 531695

- 536928

- 536906
- 536908
- 536916
- 536918

Alle Royal Line FG Diamanten sind zu 5 Stück verpackt.
 F = ISO-Figur-Nr. · KL = Kopflänge in mm
 d = Durchmesser in 1/10 mm · P = Preiskategorie

All royal line FG diamonds are packed as 5 pieces.
 F = ISO-Shape-No. · hl = head length in mm
 d = diameter in 1/10 mm · P = price category

FG Diamanten – Royal line in 2-Lagen Diamantierung

FG diamonds – Royal line with two-layer diamond technology

ISO Nr.: 806 314 F 504 superfein / superfine

806 314 F 514 fein / fine

806 314 F 524 mittel / medium





806 314 F 534 grob / coarse

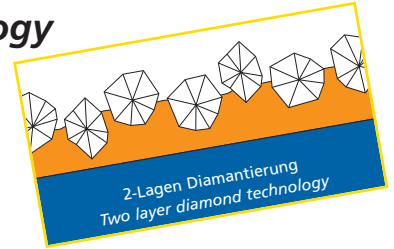

806 314 F 544 extragroß / extracoarse

Drehzahl / speed

30' - 300000 Upm / rpm



	  	F :	225	225	225	225	225
		d :	010	012	014	016	018
		KL/hl :	3	3,5	3,5	4	5
		P :	1	1	1	1	1

	 	F :	232
		d :	009
		KL/hl :	2
		P :	1

535498

533408

533405

533403

533418

533415



533428



533425



530518

530515

533438

	 	F :	233	233
		d :	010	012
		KL/hl :	3	3
		P :	1	1

	 	F :	234	234	234
		d :	012	014	016
		KL/hl :	4	5	5
		P :	1	1	1

	 	F :	236	236	236
		d :	012	014	016
		KL/hl :	5,5	5,5	5,5
		P :	1	1	1

533508

533518

533515

531658

531616

531618

531615

531628



531625



536865

536875

536888

536885

	 	F :	237	237	237
		d :	008	009	010
		KL/hl :	2,5	2,5	2,5
		P :	1	1	1

	 	F :	238	238	238	238	238	238
		d :	009	010	012	012	014	016
		KL/hl :	3	3	3	4,5	3	3
		P :	1	1	1	1	1	1

530408

530405

536248

536245

530416

530418

530415

535768

535246

535248

535245

530424

530426

530428

530425

530423

533348

533345

535934

535936

535938

535935

535896

535898

535895

535893

Alle Royal Line FG Diamanten sind zu 5 Stück verpackt.
F = ISO-Figur-Nr. · KL = Kopflänge in mm
d = Durchmesser in 1/10 mm · P = Preiskategorie

All royal line FG diamonds are packed as 5 pieces.
F = ISO-Shape-No. · hl = head length in mm
d = diameter in 1/10 mm · P = price category

FG Diamanten – Royal line in 2-Lagen Diamantierung

FG diamonds – Royal line with two-layer diamond technology

ISO Nr.: 806 314 F 504 superfein / superfine

806 314 F 514 fein / fine

806 314 F 524 mittel / medium

806 314 F 534 grob / coarse

806 314 F 544 extragroß / extracoarse

Drehzahl / speed

30' - 300000 Upm / rpm

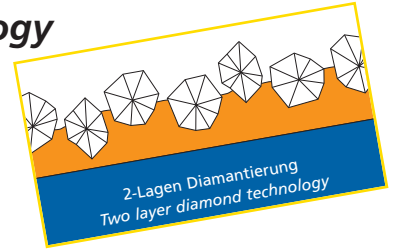

		F :	239	239	239	239	239
		d :	012	014	016	018	025
		KL/hl :	5,5	5,5	5,5	5,5	5
		P :	1	1	1	1	2

		F :	245
		d :	014
		KL/hl :	5
		P :	1

530434
530436
530438
530435
530433
530444
530448
530445
530443
530456
530458
530455
530453
530464
530468
530465
535278

533616
533618
533615

		F :	247	247	247	247	247
		d :	009	010	012	016	018
		KL/hl :	3,7	4,5	4,5	6	6
		P :	1	1	1	1	1

		F :	248	248
		d :	012	014
		KL/hl :	6	6
		P :	1	1

532618
536224
536226
536228
536225
533604
533606
533608
533605
536538
536608

531808
531805
531818
531815

		F :	249	249	249	249	249
		d :	010	012	014	016	021
		KL/hl :	8	8	8	8	8
		P :	1	1	1	1	2

531864
531866
531868
531865
531824
531826
531828
531825
531823
531834
531836
531838
531835
531833
531844
531846
531848
531845
531843
533388

Alle Royal Line FG Diamanten sind zu 5 Stück verpackt.
F = ISO-Figur-Nr. · KL = Kopflänge in mm
d = Durchmesser in 1/10 mm · P = Preiskategorie

All royal line FG diamonds are packed as 5 pieces.
F = ISO-Shape-No. · hl = head length in mm
d = diameter in 1/10 mm · P = price category

FG Diamanten – Royal line in 2-Lagen Diamantierung

FG diamonds – Royal line with two-layer diamond technology

ISO Nr.: 806 314 F 504 superfein / superfine

806 314 F 514 fein / fine

806 314 F 524 mittel / medium







806 314 F 534 grob / coarse

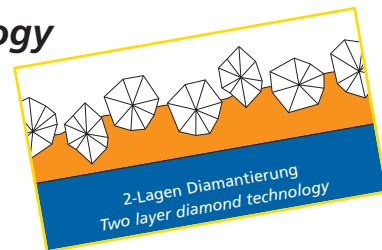



806 314 F 544 extragroß / extracoarse

Drehzahl / speed

30' - 300000 Upm / rpm















						
863	F : 250	250	250	250	250	250
	d : 010	012	014	016	018	018
	KL/hl : 10	10	10	10	10	10
	P : 1	1	1	1	1	1

				
864	F : 251	251	251	251
	d : 014	016	018	018
	KL/hl : 12	11,6	11,5	11,5
	P : 1	1	1	1

- 531964
- 531966
- 531968
- 531965
- 531906
- 531908
- 531905
- 531903
- 531916
- 531918
- 531915
- 531913
- 531926
- 531928
- 531925
- 531923
- 531936
- 531938
- 531935
- 531933





- 535784
- 531946
- 531945
- 531943
- 531955







		
863A	F : 256	256
	d : 012	012
	KL/hl : 10	10
	P : 1	1









									
368	F : 257	257	257	257	257	257	257	257	257
	d : 010	014	016	018	021	023	023	023	023
	KL/hl : 3,5	3,5	3,5	4,5	5	5	5	5	5
	P : 1	1	1	1	2	2	2	2	2

- 534308

- 532876
- 532878
- 536758
- 532805
- 532803
- 532815
- 532813
- 536595
- 536598
- 536596
- 532825
- 532828
- 532826
- 532823

				
369	F : 263	263	263	263
	d : 025	025	025	025
	KL/hl : 5,5	5,5	5,5	5,5
	P : 2	2	2	2

					
847	F : 269	269	269	269	269
	d : 016	016	016	016	016
	KL/hl : 8	8	8	8	8
	P : 1	1	1	1	1

							
390	F : 271	271	271	271	271	271	271
	d : 016	016	020	020	020	020	020
	KL/hl : 2,7	2,7	4,0	4,0	4,0	4,0	4,0
	P : 1	1	2	2	2	2	2

- 533706
- 533708
- 533705

- 532834
- 532836
- 532838
- 532835

- 533004
- 533006
- 533008
- 533005
- 530564
- 530566

Alle Royal Line FG Diamanten sind zu 5 Stück verpackt.
 F = ISO-Figur-Nr. · KL = Kopflänge in mm
 d = Durchmesser in 1/10 mm · P = Preiskategorie

All royal line FG diamonds are packed as 5 pieces.
 F = ISO-Shape-No. · hl = head length in mm
 d = diameter in 1/10 mm · P = price category

FG Diamanten – Royal line in 2-Lagen Diamantierung

FG diamonds – Royal line with two-layer diamond technology

ISO Nr.: 806 314 F 504 superfein / superfine

806 314 F 514 fein / fine

806 314 F 524 mittel / medium

806 314 F 534 grob / coarse

806 314 F 544 extragroß / extracoarse

Drehzahl / speed

30' - 300000 Upm / rpm

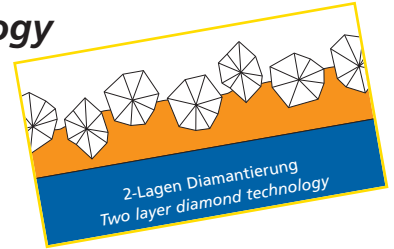

390	F : 274	
	d : 016	
	KL/hl : 3,5	
	P : 1	

533624
533626
533628
533625

379	F : 277	277	277	277	277	277
	d : 012	014	016	018	023	
	KL/hl : 3,2	3,5	3,5	5	5	
	P : 1	1	1	1	2	

532906 532934
532908 532936
532938 532946
532935 532948
532945 532914
532915 532916
532913 532918
532923 532924
532925 532926
532928 532928

876	F : 287	
	d : 010	
	KL/hl : 5	
	P : 1	

535884
535886
535888
535885

877	F : 288	288	
	d : 010	012	
	KL/hl : 6	6	
	P : 1	1	

533208
535848
535845

878	F : 289	289	289	289	289	289
	d : 010	012	014	016	018	
	KL/hl : 8	7,5	8	8	8	
	P : 1	1	1	1	1	

532134
532138 532146
532135 532148
532133 532145
532143 532106
532108
532105
532115
532113 532126
532128
532125

879	F : 290	290	290	290	290	290
	d : 010	012	014	016	018	
	KL/hl : 10	10	10	10	10	
	P : 1	1	1	1	1	

532166 532154
532168 532156
532165 532158
532155 532504
532153 532508
532505 532516
532503 532518
532513 532515
532525

877K	F : 297	297	297	297	297
	d : 012	014	016	018	
	KL/hl : 6	6	6	6	
	P : 1	1	1	1	

532008
532005 532018
532015 532028
532025 532038
532023 532035

Alle Royal Line FG Diamanten sind zu 5 Stück verpackt.
F = ISO-Figur-Nr. · KL = Kopflänge in mm
d = Durchmesser in 1/10 mm · P = Preiskategorie

All royal line FG diamonds are packed as 5 pieces.
F = ISO-Shape-No. · hl = head length in mm
d = diameter in 1/10 mm · P = price category

FG Diamanten – Royal line in 2-Lagen Diamantierung

FG diamonds – Royal line with two-layer diamond technology

ISO Nr.: 806 314 F 504 superfein / superfine

806 314 F 514 fein / fine

806 314 F 524 mittel / medium

806 314 F 534 grob / coarse

806 314 F 544 extragroß / extracoarse

Drehzahl / speed

30' - 300000 Upm / rpm

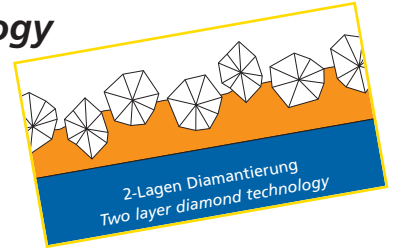

878K						
	F :	298	298	298	298	298
	d :	012	014	016	018	021
	KL/hl :	8	8	8	8	8
	P :	1	1	1	1	2

879K							
	F :	299	299	299	299	299	299
	d :	012	014	016	018	021	023
	KL/hl :	10	10	10	10	10	10
	P :	1	1	1	1	2	2

532208
532205

532218
532215
532213

532226
532228
532225
532223

532238
532235
532233

533066
533068
533065

532308
532305

532316
532318
532315

532328
532325
532323

532336
532338
532333

532368
532365

533188
533185

825				
	F :	304	304	304
	d :	018	025	040
	KL/hl :	0,7	0,9	1,3
	P :	1	2	3

392			
	F :	463	
	d :	025	
	KL/hl :	1,5	
	P :	2	

536448

536268

536438

534358

986			
	F :	464	464
	d :	031	041
	KL/hl :	2,2	3
	P :	3	3

392		
	F :	465
	d :	016
	KL/hl :	5
	P :	1



392		
	F :	465
	d :	016
	KL/hl :	5
	P :	1

533484

533494

533496

533746

533748

536794

536796

536798

Alle Royal Line FG Diamanten sind zu 5 Stück verpackt.
F = ISO-Figur-Nr. · KL = Kopflänge in mm
d = Durchmesser in 1/10 mm · P = Preiskategorie

All royal line FG diamonds are packed as 5 pieces.
F = ISO-Shape-No. · hl = head length in mm
d = diameter in 1/10 mm · P = price category

FG Diamanten – Royal line in 2-Lagen Diamantierung

FG diamonds – Royal line with two-layer diamond technology

ISO Nr.: 806 314 F 504 superfein / superfine

806 314 F 514 fein / fine

806 314 F 524 mittel / medium









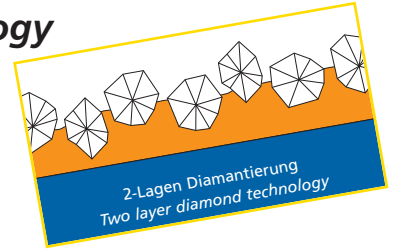

806 314 F 534 grob / coarse

806 314 F 544 extragroß / extracoarse

Drehzahl / speed

30' - 300000 Upm / rpm



 <p>833R</p> <table border="1"> <tr><td>F :</td><td>466</td><td>466</td></tr> <tr><td>d :</td><td>022</td><td>023</td></tr> <tr><td>KL/hl :</td><td>4,5</td><td>3,5</td></tr> <tr><td>P :</td><td>2</td><td>2</td></tr> </table> <p>532894 532896</p> <p>532884 532886</p>	F :	466	466	d :	022	023	KL/hl :	4,5	3,5	P :	2	2	 <p>833</p> <table border="1"> <tr><td>F :</td><td>466</td><td></td></tr> <tr><td>d :</td><td>031</td><td></td></tr> <tr><td>KL/hl :</td><td>3,5</td><td></td></tr> <tr><td>P :</td><td>3</td><td></td></tr> </table> <p>532776 532778 532775</p>	F :	466		d :	031		KL/hl :	3,5		P :	3		 <p>888</p> <table border="1"> <tr><td>F :</td><td>496</td><td></td></tr> <tr><td>d :</td><td>012</td><td></td></tr> <tr><td>KL/hl :</td><td>8</td><td></td></tr> <tr><td>P :</td><td>1</td><td></td></tr> </table> <p>535944 535948 535945</p>	F :	496		d :	012		KL/hl :	8		P :	1		 <p>370</p> <table border="1"> <tr><td>F :</td><td>507</td><td></td></tr> <tr><td>d :</td><td>023</td><td></td></tr> <tr><td>KL/hl :</td><td>6</td><td></td></tr> <tr><td>P :</td><td>2</td><td></td></tr> </table> <p>536806 536808</p>	F :	507		d :	023		KL/hl :	6		P :	2																															
F :	466	466																																																																															
d :	022	023																																																																															
KL/hl :	4,5	3,5																																																																															
P :	2	2																																																																															
F :	466																																																																																
d :	031																																																																																
KL/hl :	3,5																																																																																
P :	3																																																																																
F :	496																																																																																
d :	012																																																																																
KL/hl :	8																																																																																
P :	1																																																																																
F :	507																																																																																
d :	023																																																																																
KL/hl :	6																																																																																
P :	2																																																																																
 <p>883</p> <table border="1"> <tr><td>F :</td><td>536</td><td></td></tr> <tr><td>d :</td><td>010</td><td></td></tr> <tr><td>KL/hl :</td><td>3</td><td></td></tr> <tr><td>P :</td><td>1</td><td></td></tr> </table> <p>536986 536988</p>	F :	536		d :	010		KL/hl :	3		P :	1		 <p>889</p> <table border="1"> <tr><td>F :</td><td>540</td><td>540</td></tr> <tr><td>d :</td><td>009</td><td>010</td></tr> <tr><td>KL/hl :</td><td>3,5</td><td>4,5</td></tr> <tr><td>P :</td><td>1</td><td>1</td></tr> </table> <p>532604 532606 532608 532605</p> <p>536034 536036 536038 536035</p>	F :	540	540	d :	009	010	KL/hl :	3,5	4,5	P :	1	1	 <p>845KR</p> <table border="1"> <tr><td>F :</td><td>544</td><td>544</td><td>544</td></tr> <tr><td>d :</td><td>016</td><td>018</td><td>025</td></tr> <tr><td>KL/hl :</td><td>4</td><td>4</td><td>4</td></tr> <tr><td>P :</td><td>1</td><td>1</td><td>2</td></tr> </table> <p>534168 532848 532845</p> <p>532856 532858 532855</p>	F :	544	544	544	d :	016	018	025	KL/hl :	4	4	4	P :	1	1	2	 <p>846KR</p> <table border="1"> <tr><td>F :</td><td>545</td><td>545</td></tr> <tr><td>d :</td><td>016</td><td>018</td></tr> <tr><td>KL/hl :</td><td>6</td><td>6</td></tr> <tr><td>P :</td><td>1</td><td>1</td></tr> </table> <p>534186 534188</p> <p>532866 532868</p>	F :	545	545	d :	016	018	KL/hl :	6	6	P :	1	1	 <p>847KR</p> <table border="1"> <tr><td>F :</td><td>546</td><td></td></tr> <tr><td>d :</td><td>016</td><td></td></tr> <tr><td>KL/hl :</td><td>8</td><td></td></tr> <tr><td>P :</td><td>1</td><td></td></tr> </table> <p>534208 534205</p>	F :	546		d :	016		KL/hl :	8		P :	1		 <p>959KR</p> <table border="1"> <tr><td>F :</td><td>584</td><td></td></tr> <tr><td>d :</td><td>018</td><td></td></tr> <tr><td>KL/hl :</td><td>5,5</td><td></td></tr> <tr><td>P :</td><td>1</td><td></td></tr> </table> <p>534126</p>	F :	584		d :	018		KL/hl :	5,5		P :	1	
F :	536																																																																																
d :	010																																																																																
KL/hl :	3																																																																																
P :	1																																																																																
F :	540	540																																																																															
d :	009	010																																																																															
KL/hl :	3,5	4,5																																																																															
P :	1	1																																																																															
F :	544	544	544																																																																														
d :	016	018	025																																																																														
KL/hl :	4	4	4																																																																														
P :	1	1	2																																																																														
F :	545	545																																																																															
d :	016	018																																																																															
KL/hl :	6	6																																																																															
P :	1	1																																																																															
F :	546																																																																																
d :	016																																																																																
KL/hl :	8																																																																																
P :	1																																																																																
F :	584																																																																																
d :	018																																																																																
KL/hl :	5,5																																																																																
P :	1																																																																																

Alle Royal Line FG Diamanten sind zu 5 Stück verpackt.
F = ISO-Figur-Nr. · KL = Kopflänge in mm
d = Durchmesser in 1/10 mm · P = Preiskategorie

All royal line FG diamonds are packed as 5 pieces.
F = ISO-Shape-No. · hl = head length in mm
d = diameter in 1/10 mm · P = price category

FG Diamanten – Royal line in 2-Lagen Diamantierung

FG diamonds – Royal line with two-layer diamond technology

ISO Nr.: 806 315 F 504 superfein / *superfine*

806 315 F 514 fein / *fine*

806 315 F 524 mittel / *medium*

806 315 F 534 grob / *coarse*

806 315 F 544 extragroß / *extracoarse*

Drehzahl / *speed*

30' - 300000 Upm / *rpm*

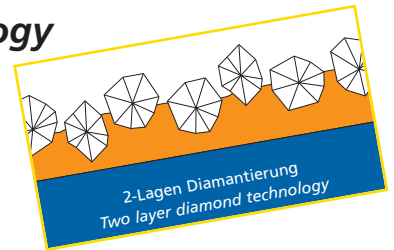

801L	F :	697	697	697	697	697	697	697
	d :	012	014	016	018	021	023	027
	KL/hl :	1,2	1,4	1,6	1,8	2,1	2,3	2,7
	P :	1	1	1	1	2	2	3

955	F :	699
	d :	008
	KL/hl :	3
	P :	1



FG Diamanten – Royal line in 2-Lagen Diamantierung

mit Tiefenmarkierung zur Inlaypräparation

FG diamonds – Royal line with two-layer diamond technology with depth marker for inlay preparation

ISO Nr.: 806 314 F 504 superfein / *superfine*

806 314 F 514 fein / *fine*

806 314 F 524 mittel / *medium*

806 314 F 534 grob / *coarse*

806 314 F 544 extragroß / *extracoarse*

Drehzahl / *speed*

30' - 300000 Upm / *rpm*

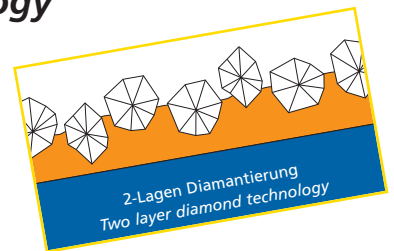

845KR	F :	544
	d :	025
	KL/hl :	4
	P :	2

846KR	F :	545
	d :	018
	KL/hl :	6
	P :	1

959KR	F :	584
	d :	018
	KL/hl :	5,5
	P :	1

532858L

532868L

534128L

Alle Royal Line FG Diamanten sind zu 5 Stück verpackt.
F = ISO-Figur-Nr. · KL = Kopflänge in mm
d = Durchmesser in 1/10 mm · P = Preiskategorie

All royal line FG diamonds are packed as 5 pieces.
F = ISO-Shape-No. · hl = head length in mm
d = diameter in 1/10 mm · P = price category



FG Diamanten – Royal line minimal invasiv

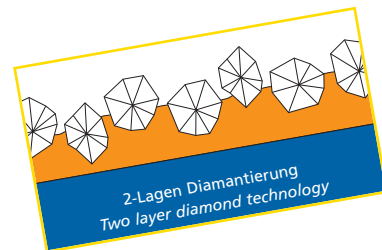

FG diamonds – Royal line minimally invasive

ISO Nr.: 806 314 F 514 fein / fine
806 314 F 524 mittel / medium

Drehzahl / speed
30' - 300000 Upm / rpm



		F:	001	001	001	001
		d:	009	012	014	016
		KL/hl:	-	-	-	-
		P:	5	5	2	2
		801				

		F:	002	002	002
		d:	008	010	012
		KL/hl:	2,5	2,5	3
		P:	5	5	5
		802			

537418

537268



537278



537288



537006
537008

537016
537018

537028

		F:	138
		d:	007
		KL/hl:	3
		P:	5
		838	

		F:	156
		d:	008
		KL/hl:	2
		P:	5
		835K	

		F:	237	237	237
		d:	008	010	012
		KL/hl:	2,5	2,5	2,5
		P:	5	5	5
		830			



537318



537106
537108



537116
537118



537126
537128

537398

		F:	238
		d:	009
		KL/hl:	3
		P:	5
		830	

		F:	271
		d:	014
		KL/hl:	3
		P:	2
		890	

		F:	536
		d:	007
		KL/hl:	3
		P:	5
		889	

		F:	540	540
		d:	007	009
		KL/hl:	3,5	3,5
		P:	5	5
		889		

537328

537388

537308

537206
537208

537216
537218

Alle Royal Line FG Diamanten sind zu 5 Stück verpackt.
F = ISO-Figur-Nr. · KL = Kopflänge in mm
d = Durchmesser in 1/10 mm · P = Preiskategorie

All royal line FG diamonds are packed as 5 pieces.
F = ISO-Shape-No. · hl = head length in mm
d = diameter in 1/10 mm · P = price category

FG Diamanten kurz – Royal line in 2-Lagen Diamantierung

FG diamonds short shank – Royal line with two-layer diamond technology









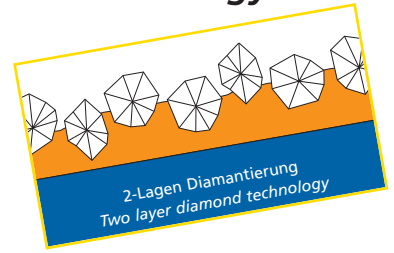

ISO Nr.: 806 313 F 514 fein / fine







Drehzahl / speed

806 313 F 524 mittel / medium

30' - 300000 Upm / rpm



	  							
		F:	001	001	001	001	001	001
		d:	009	010	012	014	016	018
		KL/hl:	-	-	-	-	-	-
P:	1	1	1	1	1	1		

	  				
		F:	002	002	002
		d:	009	012	016
		KL/hl:	2,5	3	3
P:	1	1	1		

53528ku

530078ku

530018ku

530028ku





530038ku





530048ku





535648ku





530088ku

530338ku

	 			
		F:	010	010
		d:	010	012
		KL/hl:	1	1,5
P:	1	1		

	 			
		F:	019	019
		d:	010	012
		KL/hl:	1	1,5
P:	1	1		

	 			
		F:	031	031
		d:	031	031
		KL/hl:	3,1	3
P:	3	3		

	 			
		F:	108	108
		d:	008	008
		KL/hl:	3	3
P:	1	1		

530168ku

530108ku

530208ku









530218ku





534366ku





530608ku

New

New

	 						
		F:	109	109	109	109	109
		d:	009	010	012	014	016
		KL/hl:	3	4	4	4	4
P:	1	1	1	1	1		

	 			
		F:	110	110
		d:	012	014
		KL/hl:	6	6
P:	1	1		

	 			
		F:	140	140
		d:	013	013
		KL/hl:	6,5	6,5
P:	1	1		

535518ku

530618ku

530615ku

530628ku

530638ku

535678ku

530645ku

530655ku

532463ku

Alle Royal Line FG Diamanten sind zu 5 Stück verpackt.
F = ISO-Figur-Nr. · KL = Kopflänge in mm
d = Durchmesser in 1/10 mm · P = Preiskategorie

All royal line FG diamonds are packed as 5 pieces.
F = ISO-Shape-No. · hl = head length in mm
d = diameter in 1/10 mm · P = price category

FG Diamanten kurz – Royal line in 2-Lagen Diamantierung

FG diamonds short shank – Royal line with two-layer diamond technology

ISO Nr.: 806 313 F 504 superfein / superfine

806 313 F 514 fein / fine

806 313 F 524 mittel / medium









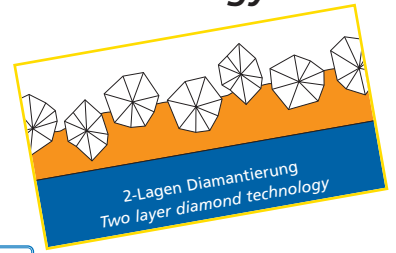



806 313 F 534 grob / coarse

806 313 F 544 extragroß / extracoarse

Drehzahl / speed

30' - 300000 Upm / rpm



	 		 				  
852	F : 161 d : 012 KL/hl : 6 P : 1	858	F : 165 d : 014 KL/hl : 8 P : 1	859	F : 166 166 d : 010 016 KL/hl : 10 10 P : 1 1	845	F : 170 d : 012 KL/hl : 4 P : 1













535588ku

535388ku

535288ku

535538ku

532068ku







	  		  		 		
846	F : 171 d : 016 KL/hl : 6 P : 1	847	F : 172 172 d : 014 018 KL/hl : 8 8 P : 1 1	848	F : 173 d : 016 KL/hl : 10 P : 1	855	F : 197 197 d : 014 023 KL/hl : 6 7 P : 1 2

535738ku

535448ku

535528ku

531418ku

					
856	F : 198 198 198 198 d : 014 016 018 025 KL/hl : 8 8 8 8 P : 1 1 1 2	850	F : 199 d : 016 KL/hl : 10 P : 1	830	F : 238 d : 012 KL/hl : 3 P : 1

532985ku



533108ku

533105ku

533103ku

531508ku

531505ku

531503ku

531515ku

531513ku

531593ku

531138ku

530428ku

Alle Royal Line FG Diamanten sind zu 5 Stück verpackt.
F = ISO-Figur-Nr. · KL = Kopflänge in mm
d = Durchmesser in 1/10 mm · P = Preiskategorie

All royal line FG diamonds are packed as 5 pieces.
F = ISO-Shape-No. · hl = head length in mm
d = diameter in 1/10 mm · P = price category

FG Diamanten kurz – Royal line in 2-Lagen Diamantierung

FG diamonds short shank – Royal line with two-layer diamond technology

ISO Nr.: 806 313 F 504 superfein / superfine

806 313 F 514 fein / fine

806 313 F 524 mittel / medium



806 313 F 534 grob / coarse



806 313 F 544 extragroß / extracoarse

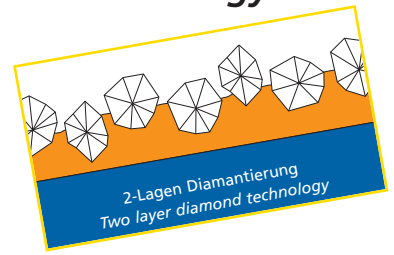

Drehzahl / speed



30' - 300000 Upm / rpm





			830RL	F : 239			
				d : 014			
				KL/hl : 5			
				P : 1			

			860	F : 245			
				d : 012			
				KL/hl : 5			
				P : 1			

			862	F : 249			
				d : 012			
				KL/hl : 8			
				P : 1			

			368	F : 257			
				d : 016			
				KL/hl : 3,5			
				P : 1			

			379	F : 277			
				d : 023			
				KL/hl : 5			
				P : 2			



535688ku





533608ku





535428ku

535268ku

532923ku

			877	F : 288			
				d : 010			
				KL/hl : 6			
				P : 1			

				878	F : 289	289	
					d : 012	014	
					KL/hl : 7,5	8	
					P : 1	1	

				878K	F : 298	298	
					d : 016	018	
					KL/hl : 8	8	
					P : 1	1	

535458ku

535348ku

535608ku

532223ku



532233ku



FG Diamanten superkurz – Royal line in 2-Lagen Diamantierung





FG diamonds supershort shank – Royal line with two-layer diamond technology

ISO Nr.: 806 312 F 534 grob / coarse

Drehzahl / speed 30' - 300000 Upm / rpm

			855	F : 197			
				d : 016			
				KL/hl : 6			
				P : 1			

			379	F : 277			
				d : 023			
				KL/hl : 5			
				P : 2			

				846KR	F : 545		
					d : 016		
					KL/hl : 6		
					P : 1		

531425sk

532925sk

534185sk

Alle Royal Line FG Diamanten sind zu 5 Stück verpackt.
F = ISO-Figur-Nr. · KL = Kopflänge in mm
d = Durchmesser in 1/10 mm · P = Preiskategorie

All royal line FG diamonds are packed as 5 pieces.
F = ISO-Shape-No. · hl = head length in mm
d = diameter in 1/10 mm · P = price category

FG Diamanten lang – Royal line in 2-Lagen Diamantierung

FG diamonds long shank – Royal line with two-layer diamond technology

ISO Nr.: 806 315 F 504 superfein / superfine

806 315 F 514 fein / fine

806 315 F 524 mittel / medium

806 315 F 534 grob / coarse

806 315 F 544 extragroß / extracoarse

Drehzahl / speed

30' - 300000 Upm / rpm



801

F:	001	001	001	001
d:	012	014	016	018
KL/hl:	-	-	-	-
P:	1	1	1	1

837L

F:	113
d:	014
KL/hl:	12
P:	1

881

F:	141	141
d:	014	016
KL/hl:	8,5	8,5
P:	1	1

530018SL

530028SL
530025SL

530038SL
530035SL

530048SL
530045SL

533798ML

852

F:	164
d:	014
KL/hl:	6
P:	1

856

F:	198
d:	016
KL/hl:	8
P:	1

850

F:	199	199
d:	012	018
KL/hl:	10	10
P:	1	1

379

F:	277
d:	023
KL/hl:	5
P:	2

532573ML

532583ML

531496ML

53118ML

532924ML
532926ML

531503ML

531163ML

532923ML

FG Diamanten für ältere Patienten

FG diamonds for senior patients

882

F:	142
d:	014
KL/hl:	12
P:	1

856

F:	198
d:	021
KL/hl:	12
P:	2

850L

F:	200
d:	016
KL/hl:	12
P:	1

864

F:	251
d:	016
KL/hl:	12
P:	1

879

F:	290
d:	016
KL/hl:	12
P:	1

53267ALZ
532678LZ

53152ALZ
531528LZ

53115ALZ
531158LZ

53194ALZ
531948LZ

53251ALZ
532518LZ

Alle Royal Line FG Diamanten sind zu 5 Stück verpackt.
F = ISO-Figur-Nr. · KL = Kopflänge in mm
d = Durchmesser in 1/10 mm · P = Preiskategorie

All royal line FG diamonds are packed as 5 pieces.
F = ISO-Shape-No. · hl = head length in mm
d = diameter in 1/10 mm · P = price category

WST Diamanten – Royal line in 2-Lagen Diamantierung

CA diamonds – Royal line with two-layer diamond technology

ISO Nr.: 806 204 F 504 superfein / superfine
 806 204 F 514 fein / fine
 806 204 F 524 mittel / medium
 806 204 F 534 grob / coarse
 806 204 F 544 extragrob / extracoarse

Drehzahl / speed
 30' - 150000 Upm / rpm

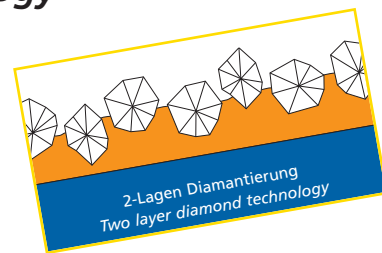

801

F:	001	001	001	001	001	001	001	001	001
d:	009	010	012	014	016	018	021	023	029
KL/hl:	-	-	-	-	-	-	-	-	-
P:	6	6	6	6	6	6	6	6	7

60001098W 60001108W 60001128W 60001148W 60001168W 60001188W 60001218W 60001238W 60001298W

805

F:	010	010	010
d:	012	014	016
KL/hl:	1,6	2,0	2,0
P:	6	6	6

60010128W 60010148W 60010168W

835

F:	109	109	109	109
d:	010	012	014	016
KL/hl:	4,0	4,0	4,0	4,0
P:	6	6	6	6

60109108W 60109128W 60109148W 60109168W



859

F:	166
d:	012
KL/hl:	10
P:	6

60166128W

848

F:	173	173
d:	014	018
KL/hl:	10	10
P:	6	6

60173148W 60173168W

WST Diamanten – Royal line in 2-Lagen Diamantierung

CA diamonds – Royal line with two-layer diamond technology

ISO Nr.: 806 204 F 504 superfein / superfine
 806 204 F 514 fein / fine
 806 204 F 524 mittel / medium
 806 204 F 534 grob / coarse
 806 204 F 544 extragroß / extracoarse

Drehzahl / speed
 30' - 150000 Upm / rpm

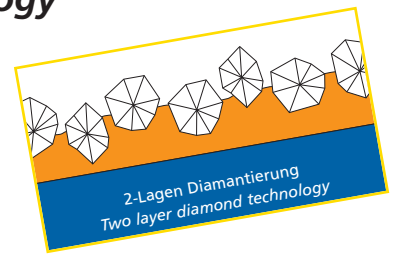

850

F :	199	199	199
d :	012	014	016
KL/hl :	10	10	10
P :	6	6	6

60199128W

60199148W

60199168W

862

F :	249	249
d :	012	014
KL/hl :	8,0	8,0
P :	6	6

60249128W 60249144W

863

F :	250
d :	012
KL/hl :	10,0
P :	6

60250128W

368

F :	257
d :	023
KL/hl :	5,0
P :	6

60257236W
 60257238W

379

F :	277
d :	023
KL/hl :	4,2
P :	6

60277236W
 60277238W

Alle Royal Line WST Diamanten sind zu 6 Stück verpackt.
 F = ISO-Figur-Nr. · KL = Kopflänge in mm
 d = Durchmesser in 1/10 mm · P = Preiskategorie

All royal line CA diamonds are packed as 6 pieces.
 F = ISO-Shape-No. · hl = head length in mm
 d = diameter in 1/10 mm · P = price category

FG Diamanten – Turbo Laser in 2-Lagen Diamantierung

FG diamonds – Turbo Laser with two-layer diamond technology

ISO Nr.: 806 314 F 504 superfein / superfine

806 314 F 514 fein / fine

806 314 F 524 mittel / medium

806 314 F 544 extragrob / extracoarse

Drehzahl / speed

30' - 300000 Upm / rpm

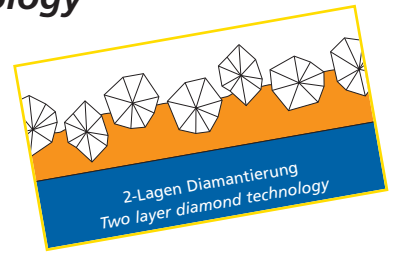

F :	111	112	115	115	131	140	158	165	172	198	198	198	198	199
d :	012	016	014	018	016	010	020	014	016	014	016	018	018	016
KL/hl :	8	10	8	10	11	6	8	8	8	8	8	8	8	10
P :	8	8	8	8	8	8	8	8	8	8	8	8	8	8

530070 530080 534238 534248 530050 532020 530020 530170 530100 530350 530210 530230 530250 530090

Vermeidet Aquaplaning Effekte!
Avoids aquaplaning effect!

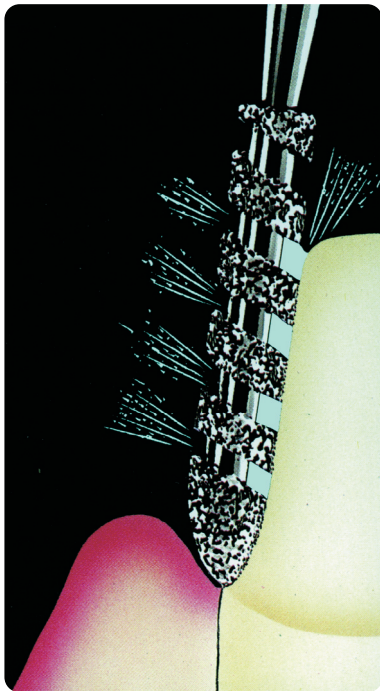

F :	248	250	250	257	290	298
d :	014	012	016	023	016	018
KL/hl :	6	10	10	4,5	10	8
P :	8	8	8	8	8	8

532120 530010 530110 532040 531040 530040 530060 530190



- ✓ Nahezu verdoppelte Abtragsleistung
Significantly improved abrasive power
- ✓ Kühleres Schleifen
Does not harm the pulp (cool grinding)
- ✓ Bessere Führung des FG bei der exakten Hohlkehl-Präparation
Better control during preparation

Turbo Laser FG Diamanten sind zu 2 Stück verpackt.
F = ISO-Figur-Nr. · KL = Kopflänge in mm
d = Durchmesser in 1/10 mm · P = Preiskategorie

Turbo Laser FG diamonds are packed as 2 pieces.
F = ISO-Shape-No. · hl = head length in mm
d = diameter in 1/10 mm · P = price category

FG Diamanten – Turbo Comp in 2-Lagen Diamantierung

FG diamonds – Turbo Comp with two-layer diamond technology















- ✓ Vollständig diamantierte Oberfläche
Surface fully diamond coated
- ✓ Spiralgeometrie für kühles, kontrolliertes Schleifen
Spiral geometry, cool grinding with optimal control
- ✓ Vermeidet Aquaplaning
Avoids aquaplaning
- ✓ Effizienter Materialabtrag
Efficient removal of material
- ✓ Reduzierter Anpressdruck
Less pressure needed



ISO Nr.: 806 314 F 524 mittel / *medium*
806 314 F 544 extragrob / *extracoarse*

Drehzahl / *speed*
30' - 300000 Upm / *rpm*

												
F :	131	158	158	178	178	178	199	199	250	250	290	290
d :	016	014	016	016	018	025	014	016	014	016	014	016
KL/hl :	11	8	8	8	10	10	10	10	10	10	10	10
P :	8	8	8	8	8	8	8	8	8	8	8	8
	533050	533070	533170	534253	534258	534283	534288	534273	534278	533090	533190	533010
											533110	533060
												533160

Turob Comp FG Diamanten sind zu 2 Stück verpackt.
F = ISO-Figur-Nr. · KL = Kopflänge in mm
d = Durchmesser in 1/10 mm · P = Preiskategorie

*Turbo Comp FG diamonds are packed as 2 pieces.
F = ISO-Shape-No. · hl = head length in mm
d = diameter in 1/10 mm · P = price category*

Redux FG Diamanten in 2-Lagen Diamantierung

Redux FG diamonds with two-layer diamond technology

ISO Nr.: 806 314 F 524 mittel / medium
 806 314 F 534 grob / coarse

Drehzahl / speed
 30' - 300000 Upm / rpm

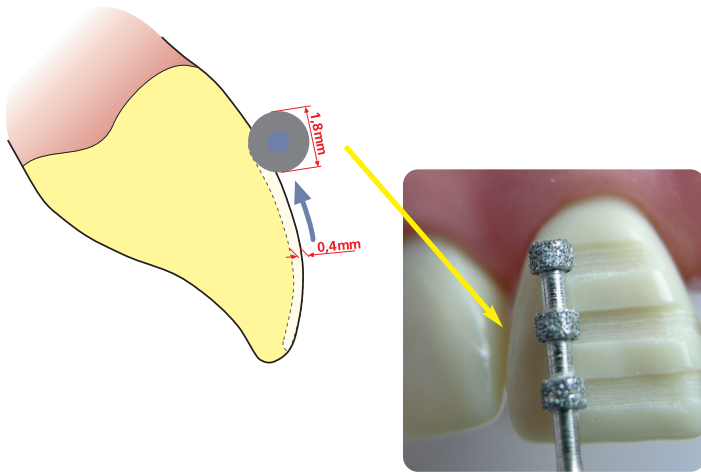
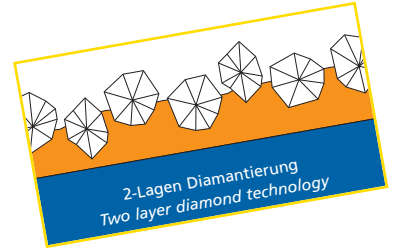

F: 512	F: 513	F: 519	F: 520	F: 521
d: 018	d: 018	d: 018	d: 016	d: 018
KL/hl: 6	KL/hl: 8	KL/hl: 7,8	KL/hl: 10	KL/hl: 10
P: 3	P: 3	P: 3	P: 3	P: 3

534075

534015

534025

533738

534005

F: 552	F: 552	F: 552	F: 552	F: 560	F: 560
d: 016	d: 018	d: 021	d: 018	d: 018	d: 018
KL/hl: 8	KL/hl: 6,5	KL/hl: 8	KL/hl: 7	KL/hl: 7	KL/hl: 7
P: 4	P: 4	P: 4	P: 4	P: 4	P: 4

533358

530508

530505

533378

534108

534105

Redux FG Diamanten sind zu 2 Stück verpackt.
 F = ISO-Figur-Nr. · KL = Kopflänge in mm
 d = Durchmesser in 1/10 mm · P = Preiskategorie

Redux FG diamonds are packed as 2 pieces.
 F = ISO-Shape-No. · hl = head length in mm
 d = diameter in 1/10 mm · P = price category

FG Diamanten Tiefenmarkierer in 2-Lagen Diamantierung

FG diamonds depth markers with two-layer diamond technology

ISO Nr.: 806 314 F 524 mittel / medium

Drehzahl / speed
30' - 300000 Upm / rpm

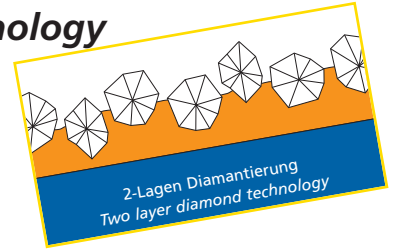

F :	156	156	156	156
d :	009	009	009	009
KL/hl :	0,6	1,0	1,5	2,0
P :	2	2	2	2



konisch 8°
conical 8°

F :	168	168	168	168	168	168
d :	017	017	017	017	017	017
KL/hl :	1,0	1,5	1,8	2,0	2,2	2,4
P :	2	2	2	2	2	2



F :	107	107	107	107	107	107
d :	017	017	017	017	017	017
KL/hl :	1,0	1,5	1,8	2,0	2,2	2,4
P :	2	2	2	2	2	2



F :	107	107	107	107	107	107
d :	009	009	009	009	009	009
KL/hl :	1,0	1,5	1,8	2,0	2,2	2,4
P :	2	2	2	2	2	2

534408-06
534408-10
534408-15
534408-20

534418-10
534418-15
534418-18
534418-20
534418-22
534418-24

534428-10
534428-15
534428-18
534428-20
534428-22
534428-24

534438-10
534438-15
534438-18
534438-20
534438-22
534438-24

FG Diamanten sind zu 5 Stück verpackt.
F = ISO-Figur-Nr. · KL = Kopflänge in mm
d = Durchmesser in 1/10 mm · P = Preiskategorie

FG diamonds are packed as 5 pieces.
F = ISO-Shape-No. · hl = head length in mm
d = diameter in 1/10 mm · P = price category

FG Piranhas in 3-Lagen Diamantierung

FG piranhas with three-layer diamond technology

ISO Nr.: 806 314 F 504 superfein / superfine
 806 314 F 514 fein / fine
 806 314 F 524 mittel / medium
 806 314 F 534 grob / coarse

Drehzahl / speed
 30' - 300000 Upm / rpm

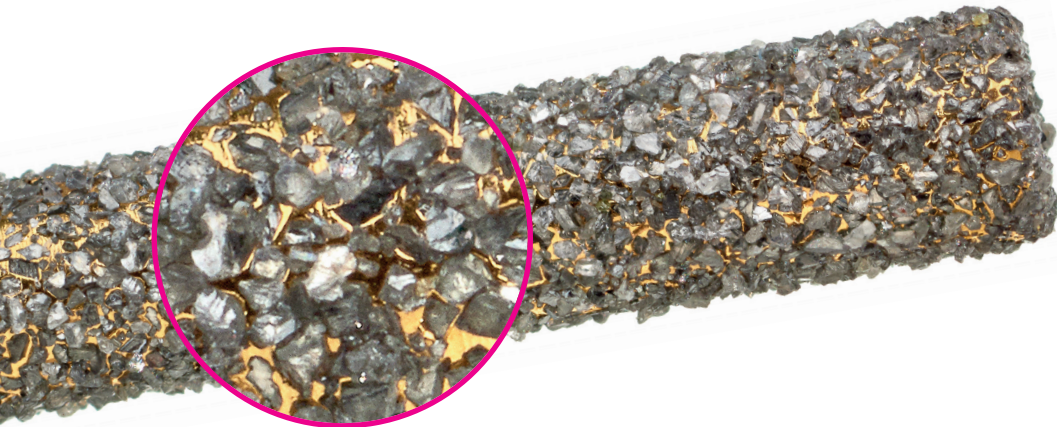
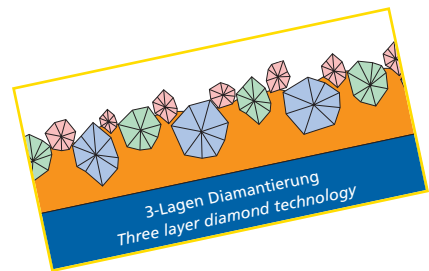

 801	F:	001	001	001	001	001	001	001	001
	d:	008	010	012	014	016	018	021	027
	KL/hl:	0,7	0,9	1,1	1,3	1,5	1,8	2,1	2,7
	P:	8	8	8	8	8	8	9	9

 805	F:	010	010
	d:	012	014
	KL/hl:	1,5	1,5
	P:	8	8

539008S

539178S
539175S

539285S
539255S

539185S
539155S

539928S
539925S

539938S
539935S

539218S
539215S

539278S

539428S

539438S

 811	F:	039
	d:	033
	KL/hl:	4,5
	P:	9

 909	F:	068
	d:	037
	KL/hl:	1
	P:	9

 835	F:	109
	d:	010
	KL/hl:	4
	P:	8

 837	F:	111
	d:	016
	KL/hl:	8
	P:	8

539308S

539688S

539998S

539868

Piranhas sind zu 2 Stück verpackt.
 F = ISO-Figur-Nr. · KL = Kopflänge in mm
 d = Durchmesser in 1/10 mm · P = Preiskategorie

Piranhas are packed as 2 pieces.
 F = ISO-Shape-No. · hl = head length in mm
 d = diameter in 1/10 mm · P = price category



FG Piranhas in 3-Lagen Diamantierung

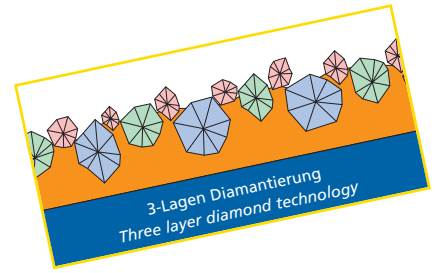

FG piranhas with three-layer diamond technology

ISO Nr.: 806 314 F 504 superfein / superfine
 806 314 F 514 fein / fine
 806 314 F 524 mittel / medium
 806 314 F 534 grob / coarse



Drehzahl / speed
 30' - 300000 Upm / rpm







		F : 140	140
		d : 012	014
		KL/hl : 6,5	6
		P : 8	8

		F : 141	141	141	141
		d : 012	014	016	018
		KL/hl : 8,5	8,5	8,5	8,5
		P : 8	8	8	8

539018
539015
539028
539025
539034
539036
539038
539035
539046
539048
539045
539316
539315
539318



		F : 156	
		d : 012	
		KL/hl : 5	
		P : 8	



		F : 158	158	158
		d : 010	012	014
		KL/hl : 8	8	8
		P : 8	8	8



		F : 161	
		d : 012	
		KL/hl : 6	
		P : 8	



539078
539075
5390645
5390545
5390685
5390585
5390555
539086
539088
539085
539765
539785
539755

New →

		F : 165	
		d : 014	
		KL/hl : 8	
		P : 8	

		F : 166	166
		d : 010	018
		KL/hl : 10	10
		P : 8	8

		F : 167	
		d : 010	
		KL/hl : 11	
		P : 8	

		F : 173	
		d : 014	
		KL/hl : 10	
		P : 8	

5390965
5390985
5390955
5397965
5397865
5397955
5397855
539346
5392555

Piranhas sind zu 2 Stück verpackt.
 F = ISO-Figur-Nr. · KL = Kopflänge in mm
 d = Durchmesser in 1/10 mm · P = Preiskategorie

Piranhas are packed as 2 pieces.
 F = ISO-Shape-No. · hl = head length in mm
 d = diameter in 1/10 mm · P = price category



FG Piranhas in 3-Lagen Diamantierung

FG piranhas with three-layer diamond technology

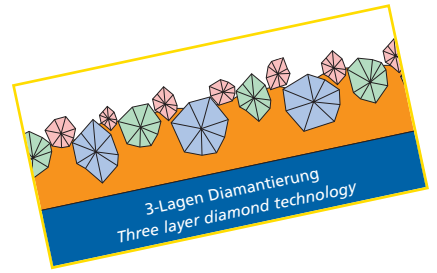

ISO Nr.: 806 314 F 504 superfein / superfine
 806 314 F 514 fein / fine
 806 314 F 524 mittel / medium
 806 314 F 534 grob / coarse

Drehzahl / speed
 30' - 300000 Upm / rpm





		F : 197	197
		d : 012	014
		KL/hl : 6	6
		P : 8	8



5391585
 5392445
 5391685

		F : 198	198	198
		d : 016	018	021
		KL/hl : 8	8	8
		P : 8	8	9



5395845
 5395865
 5395885
 5395855
 5395945
 5395965
 5395985
 5395955
 5396065

		F : 199	199	199	199	199
		d : 010	012	014	016	018
		KL/hl : 10	10	10	10	10
		P : 8	8	8	8	8



5391045
 5391085
 5391055
 539116
 539118
 539115
 539126
 539128
 539125
 5391445
 9391465
 5391485
 5391455
 539176

		F : 225	
		d : 018	
		KL/hl : 5	
		P : 8	



539136
 539138
 539135

		F : 234	234
		d : 014	016
		KL/hl : 5	5
		P : 8	8



539188
 539185
 539195

		F : 238	238
		d : 012	014
		KL/hl : 3	3
		P : 8	8

5392085
 5392055
 5392885

		F : 249	
		d : 012	
		KL/hl : 8	
		P : 8	

539236
 539238
 539235

		F : 250	250	250
		d : 012	014	016
		KL/hl : 10	10	10
		P : 8	8	8

5392645
 539266
 539268
 539265
 539276
 539278
 539275
 539286
 539288
 539285

Piranhas sind zu 2 Stück verpackt.
 F = ISO-Figur-Nr. · KL = Kopflänge in mm
 d = Durchmesser in 1/10 mm · P = Preiskategorie

Piranhas are packed as 2 pieces.
 F = ISO-Shape-No. · hl = head length in mm
 d = diameter in 1/10 mm · P = price category



FG Piranhas in 3-Lagen Diamantierung

FG piranhas with three-layer diamond technology

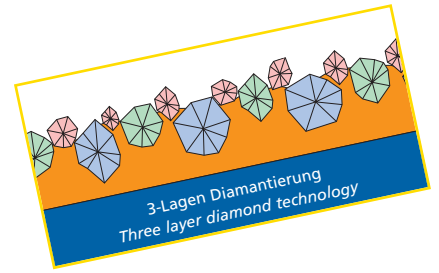

ISO Nr.: 806 314 F 504 superfein / superfine
 806 314 F 514 fein / fine
 806 314 F 524 mittel / medium
 806 314 F 534 grob / coarse

Drehzahl / speed
 30' - 30000 Upm / rpm





		F : 251
		d : 016
		KL/hl : 11,6
		P : 8



539296
 539298
 539295

		F : 257	257
		d : 018	023
		KL/hl : 4,5	5
		P : 8	9



539326
 539328
 539325
 539354
 539356
 539358
 539355

		F : 269
		d : 016
		KL/hl : 8
		P : 8



539494S
 539498S

		F : 277	277
		d : 023	023
		KL/hl : 4,5	5,5
		P : 9	9



539416
 539418
 539415
 539166
 539165

		F : 289	289	289
		d : 010	012	014
		KL/hl : 8	7,5	8
		P : 8	8	8



539516
 539518
 539515
 539526
 539528
 539525
 539536
 539538
 539535

		F : 290	290	290
		d : 012	014	016
		KL/hl : 10	10	10
		P : 8	8	8

539616
 539618
 539615
 539626
 539628
 539625
 539636S
 539638S
 539635S

		F : 297
		d : 012
		KL/hl : 6
		P : 8

539675

		F : 298	298	298	298	298
		d : 014	016	018	020	022
		KL/hl : 8	8	8	8	8
		P : 8	8	8	9	9

539726
 539728
 539725
 539738
 539735
 539746
 539745
 539755
 539765

Piranhas sind zu 2 Stück verpackt.
 F = ISO-Figur-Nr. · KL = Kopflänge in mm
 d = Durchmesser in 1/10 mm · P = Preiskategorie

Piranhas are packed as 2 pieces.
 F = ISO-Shape-No. · hl = head length in mm
 d = diameter in 1/10 mm · P = price category

FG Piranhas in 3-Lagen Diamantierung

FG piranhas with three-layer diamond technology

ISO Nr.: 806 314 F 504 superfein / superfine
 806 314 F 514 fein / fine
 806 314 F 524 mittel / medium
 806 314 F 534 grob / coarse

Drehzahl / speed
 30' - 300000 Upm / rpm

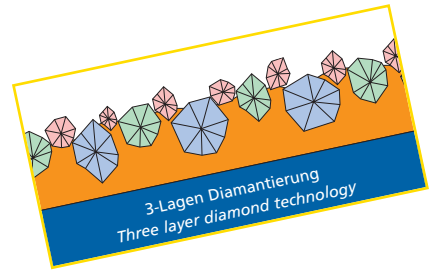

879K

F :	299	299	299	299	299
d :	012	014	016	018	021
KL/hl :	10	10	10	10	10
P :	8	8	8	8	9

889

F :	540
d :	009
KL/hl :	3,5
P :	8

845KR

F :	544	544
d :	018	025
KL/hl :	4	4
P :	8	9

801L

F :	697	697	697
d :	010	012	016
KL/hl :	1,0	1,2	1,6
P :	8	8	8

539816, 539818, 539815, 539826, 539825, 539836, 539838, 539835, 539845, 539855, 539694S, 539696S, 539698S, 539904, 539954S, 539908, 539958S, 539218, 539228, 539248

New →

FG Piranhas lang

FG piranhas long

ISO Nr.: 806 315

Drehzahl / speed
 30' - 300000 Upm / rpm

801

F :	001	001	001	001
d :	012	014	016	018
KL/hl :	1,1	1,3	1,5	1,8
P :	10	10	10	10

539228SL, 539918SL, 539928SL, 539938SL

Piranhas sind zu 2 Stück verpackt.
 F = ISO-Figur-Nr. · KL = Kopflänge in mm
 d = Durchmesser in 1/10 mm · P = Preiskategorie

Piranhas are packed as 2 pieces.
 F = ISO-Shape-No. · hl = head length in mm
 d = diameter in 1/10 mm · P = price category

Diafutura® - die neue Präp-Technik

Diafutura® - the new prep-technique

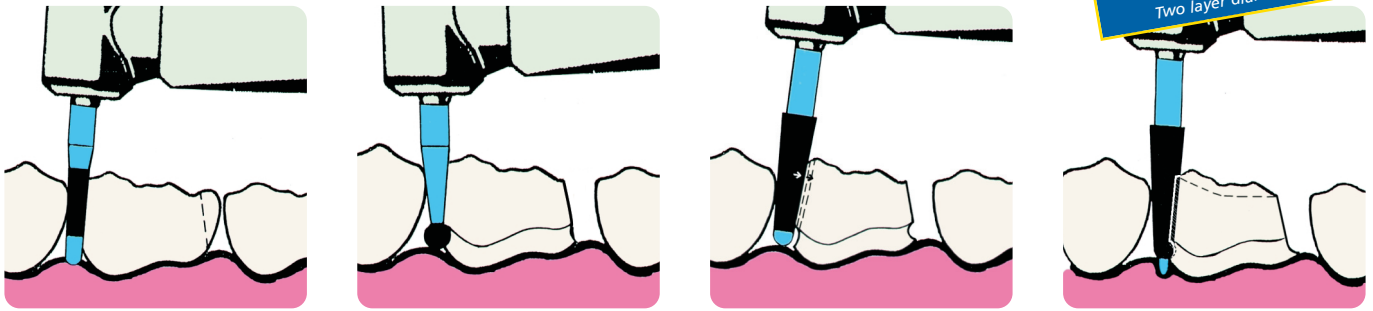
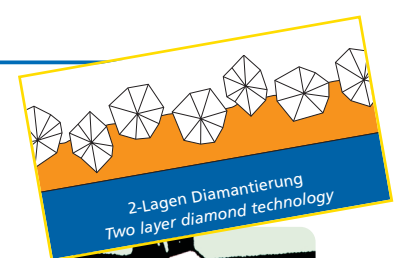

Drehzahl / speed
30'-300000 Upm / rpm

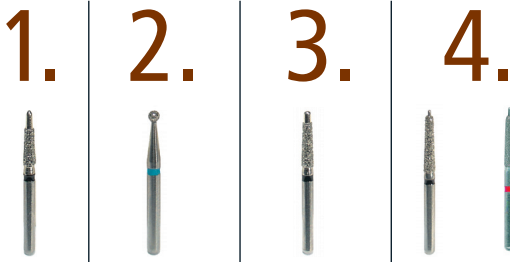

1. Abtrag der Kontaktpunkte, mesial-distal (ohne Verletzungsgefahr).
2. Zur Festlegung der Präp-Grenze.
3. Zum zirkulären Abtrag ohne Verletzung der Präp-Stufe.
4. Zum exakten Beschleifen der zirkulären Präp-Grenze, mit Hilfe eines Präzisions-Führungspins.

1. Remove contact points, mesial-distal (without danger of injury).
2. Determination of prep boundary.
3. Circular grinding without damaging the prep-stage.
4. Precise grinding of the prep-stage with the help of a precision guide-pin.

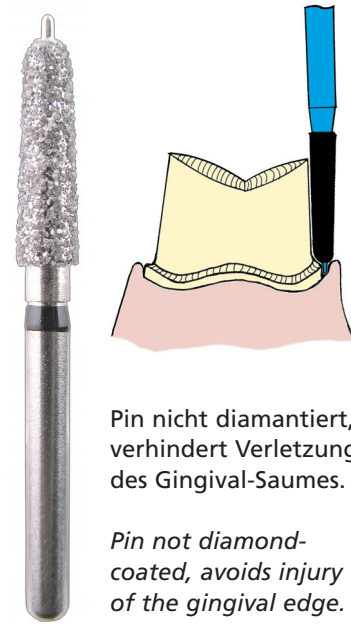

Pin nicht diamantiert, verhindert Verletzung des Gingival-Saumes.

Pin not diamond-coated, avoids injury of the gingival edge.

Intro-Sets

1. Anterior

2. Posterior

F :	508	001	198	508	508
d :	014	014	016	016	016
KL/hl :	8	-	8	9	9
P :	3	1	3	3	3

Set
1+2

F :	508	001	198	508	508
d :	014	016	021	021	021
KL/hl :	8	-	8	9	9
P :	3	1	9	9	9

Bestell-Nr.:
Order-No:

531575

530028

531555

531555

531556

Set

530022

532022

531575

530038

531545

531565

531566

531022

Diafutura® FGs sind zu 2 Stück verpackt.
F = ISO-Figur-Nr. · KL = Kopflänge in mm
d = Durchmesser in 1/10 mm · P = Preiskategorie

Diafutura® FGs are packed as 2 pieces.
F = ISO-Shape-No. · hl = head length in mm
d = diameter in 1/10 mm · P = price category

Diafatur® - die neue Präp-Technik

Diafatur® - the new prep-technique



Abb.: AG Keramik

Vollkeramiksysteme erfordern aus Gründen der Stabilität unabdingbar das Einhalten von Mindestanforderungen hinsichtlich Wandstärken. Die Wandstärken sollten an den Seitenwänden mindestens 0,8 - 1 mm, am Kronenrand 0,5 - 0,8 mm betragen.

Des Weiteren ist bei Versorgungen aus Zirkoniumdioxid und Aluminiumoxid als Grundgerüst eine Präparation mit einer ausgeprägten Stufe in einem Winkel von 45 - 90° dringend zu empfehlen, wobei runden Schultern der Vorzug zu geben ist. Arbitrarisches Vorgehen verzeihen moderne Vollkeramiksysteme nie, sei es Press-, Schicht- oder Zirkondioxidkeramik.

Diafatur® C für Silikatkeramiken (Feldspat- und Glaskeramik, LS2) und Diafatur® Z für Oxidkeramiksysteme (Al_2O_3 , ZrO_2) tragen durch ihr Design den erforderlichen Mindeststärken inklusive eines Sicherheitspuffers Rechnung. Das Design ermöglicht in beiden Fällen einfach und problemlos die Konturierung einer 90° runden Schulter. Durch den Anschlag des Führungspins im marginalen Bereich wird kontrolliertes Abtragen von Zahnschubstanz mit definierter Eindringtiefe ermöglicht; gleichzeitig bietet dies einen Schutz gegen eine Verletzung des Zahnfleischrandes.

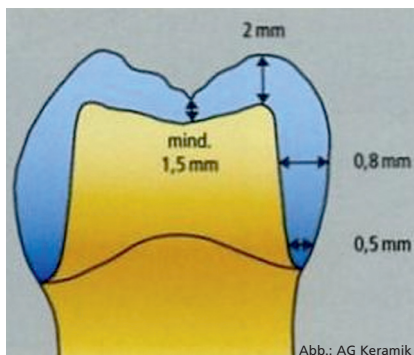

In case of all-ceramic restorations the minimum requirements in terms of wall strength must be met for stability reasons. Wall strengths at the lateral surfaces should be at a minimum 0.8 - 1 mm, at the crown margin 0.5 - 0.8 mm. Moreover, restorations using zirconium oxide and aluminium oxide as framework require preparation

with an accentuated shoulder at an angle of 45 - 90°, preferably with round shoulders. Arbitrary procedures are never tolerated by modern all-ceramic restorations, be they press or layer ceramics or zirconia.

Diafatur® C for silicate ceramics (feldspar and glass ceramics, LS2) and Diafatur® Z for oxide ceramic systems (Al_2O_3 , ZrO_2) take account of the required minimum strengths including a safety margin by virtue of their design. This design facilitates simple contouring of a 90° round shoulder. The precision guide pin helps to achieve a controlled removal of tooth material at a defined penetration depth, at the same time the pin also protects against injuries to the gingival margin.

Diafatur® C

Drehzahl / speed 30'-300000 Upm / rpm

Für vollkeramische Restaurationen aus Silikatkeramiken, z.B. LS2.

For all-ceramic restorations with silicate ceramics, e.g. LS2.

F :	508	001	152	509	509
d :	014	018	020	020	020
KL/hl :	8	-	8	8	8
P :	3	1	9	9	9

Bestell-Nr.:
Order-No:

531575

530048

531535C

531555C

531556C

Set **530022C**

Diafatur® Z

Drehzahl / speed 30'-300000 Upm / rpm

Für vollkeramische Restaurationen aus Zirkon.
For all-ceramic zirconia restorations.

F :	508	001	152	509	509
d :	014	014	016	018	018
KL/hl :	8	-	8	8	8
P :	3	1	3	3	3

Bestell-Nr.:
Order-No:

531575

530028

531545Z

531565Z

531566Z

Set **530022Z**

Diafatur® FGs sind zu 2 Stück verpackt.
F = ISO-Figur-Nr. · KL = Kopflänge in mm
d = Durchmesser in 1/10 mm · P = Preiskategorie

Diafatur® FGs are packed as 2 pieces.
F = ISO-Shape-No. · hl = head length in mm
d = diameter in 1/10 mm · P = price category

Inlaypräparationskit (Keramik) Kit inlay preparation (ceramics)

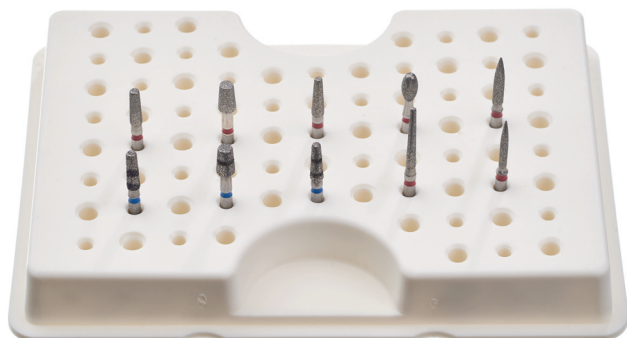

200128

Präparationsset für vollkeramische Inlays und Teilkronen. Die enthaltenen Tiefenmarkierer erleichtern das Einhalten der okklusalen Mindeststärken von Keramikrestaurationen. Die Maßangabe der Tiefenmarkierung ist in der Darstellung auf Seite 22 beschrieben.

Bestell-Nr. Order number	ISO Nummer ISO number	Fig.Nr shape no.	Körnung grit	ø 1/10 mm ø 1/10 mm	KL mm hl mm	VE pu	P P
534128L	806 314	584	524	018	5,5	5	1
532858L	806 314	544	524	025	4	5	2
532868L	806 314	545	524	018	6	5	1
531126	806 314	199	514	014	10	5	1
531826	806 314	249	514	012	8	5	1
534126	806 314	584	514	018	5,5	5	1
532856	806 314	544	514	025	4	5	2
532866	806 314	545	514	018	6	5	1
532926	806 314	277	514	023	5	5	2
531846	806 314	249	514	016	8	5	1

Preparation kit for full-ceramic inlays and partial crowns. The depth markers contained in this kit facilitate the control of occlusal minimum widths of ceramic restorations. The specification of the depth markings are shown on page 22.

Kavitätenpräparationskit Cavity kit

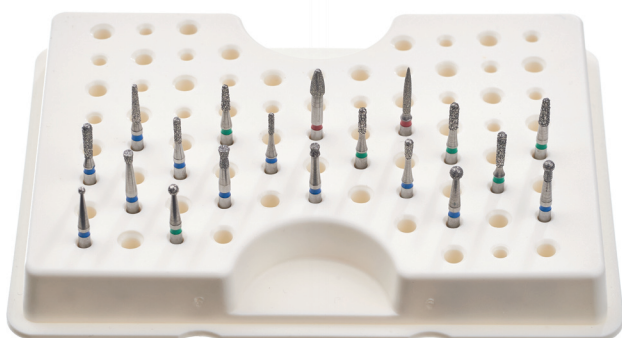

200129

Dieses Set zur Kavitätenpräparation enthält Diamantinstrumente unterschiedlicher Formen in drei Körnungen. Die spezielle Auswahl ermöglicht den schnellen, gezielten Abtrag kariöser Zahnschubstanz und die einfache Gestaltung der Kavitätenform für Restaurationen aus Amalgam oder Komposit.

Bestell-Nr. Order number	ISO Nummer ISO number	Fig.Nr shape no.	Körnung grit	ø 1/10 mm ø 1/10 mm	KL mm hl mm	VE pu	P P
530078	806 314	001	524	010	-	5	1
530025	806 314	001	534	014	-	5	1
530048	806 314	001	524	018	-	5	1
530338	806 314	002	524	016	3	5	1
530118	806 314	010	524	014	1,5	5	1
530238	806 314	019	524	016	3	5	1
530498	806 314	032	524	014	1,6	5	1
530428	806 314	238	524	012	3	5	1
536865	806 314	236	534	012	5,5	5	1
530448	806 314	239	524	014	5,5	5	1
530618	806 314	109	524	010	4	5	1
536028	806 314	137	524	008	3,5	5	1
535775	806 314	137	534	010	4	5	1
535825	806 314	137	534	012	4	5	1
532075	806 314	170	534	014	4	5	1
532188	806 314	171	524	012	6	5	1
536295	806 314	196	534	012	4	5	1
530566	806 314	271	514	020	4	5	2
531826	806 314	249	514	012	8	5	1

This set contains diamond instruments in various grit in three different grit sizes. The proposed selection allows a fast and focused removal of carious material as well as an easy preparation of the cavity for composite or amalgam restorations.

Kronen- und Brückenpräparationskit Crown prep tool kit

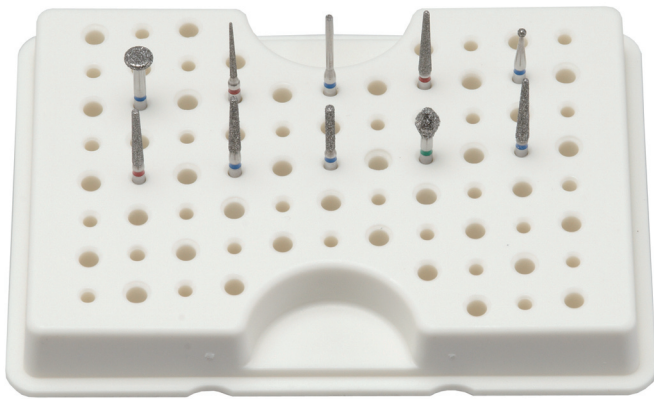

200157

Bestell-Nr. Order number	ISO Nummer ISO number	Fig.Nr shape no.	Körnung grit	ø 1/10 mm ø 1/10 mm	KL mm hl mm	VE pu	P P
530018	806 314	001	524	012	-	5	1
530305	806 314	039	534	033	4,5	5	3
530758	806 314	111	524	012	8	5	1
531028	806 314	173	524	016	10	5	1
531026	806 314	173	514	016	10	5	1
531168	806 314	200	524	018	11,5	5	1
531166	806 314	200	514	018	11,5	5	1
530708	806 314	150	524	010	-	5	1
531106	806 314	199	514	010	10	5	1
532718	806 314	068	524	037	1	5	3

Finierkit Finishing kit

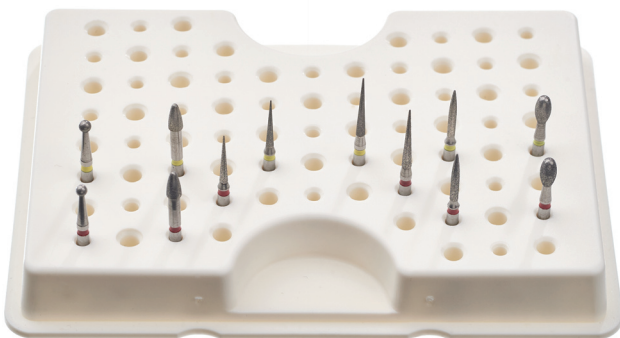

200131

Bestell-Nr. Order number	ISO Nummer ISO number	Fig.Nr shape no.	Körnung grit	ø 1/10 mm ø 1/10 mm	KL mm hl mm	VE pu	P P
530036	806 314	001	514	016	-	5	1
530566	806 314	271	514	020	4	5	2
531326	806 314	165	514	012	8	5	1
531886	806 314	166	514	014	10	5	1
531826	806 314	249	514	012	8	5	1
532926	806 314	277	514	023	5	5	2
530034	806 314	001	504	016	-	5	1
530564	806 314	271	504	020	4	5	2
531324	806 314	165	504	012	8	5	1
531884	806 314	166	504	014	10	5	1
531824	806 314	249	504	012	8	5	1
532924	806 314	277	504	023	5	5	2

Dieses Set enthält Diamantinstrumente in speziellen Formen zur finalen Bearbeitung von Präparationen, insbesondere bei Komposit-Versorgungen. Die Instrumente in zwei unterschiedlich feinen Körnungen sorgen für eine perfekte Oberflächenbeschaffenheit.

This set contains diamond instruments in specific shapes for finishing preparations, especially composite preparations. The selection of instruments in fine and superfine diamond grit delivers a perfect finished surface.

Präparationskit Veneers Veneer prep tool kit

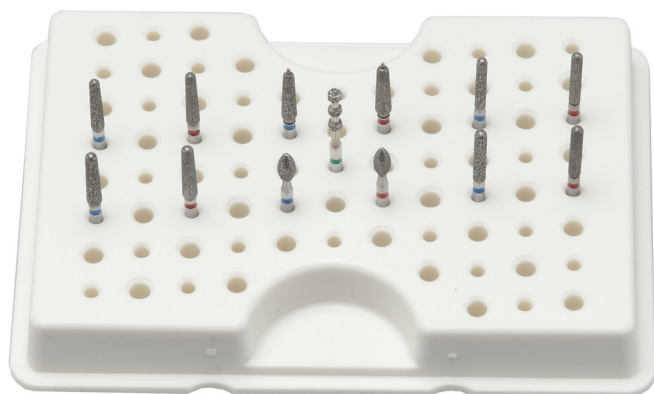

200125

Präparations-Set zum sicheren Anlegen von Lagern für Veneers. Der Tiefenmarkierer ermöglicht mit den tiefenkongruenten Instrumenten mit Führungsstift eine Präparationstiefe von mindestens 0,4 mm. Die Stirnradien sind nicht sphärisch sondern bilden ein Kugelsegment und ermöglichen Schultern wenn nötig bis zu 90° als Grundlage von ästhetisch hochwertigen Versorgungen.

Bestell-Nr. Order number	ISO Nummer ISO number	Fig.Nr shape no.	Körnung grit	ø 1/10 mm ø 1/10 mm	KL mm hl mm	VE pu	P P
531518ZF	806 314	198	524	018	9	5	2
531528ZF	806 314	198	524	020	9	5	2
531516ZF	806 314	198	514	018	9	5	2
531526ZF	806 314	198	514	020	9	5	2
531568ZF	806 314	508	524	022	8	5	2
532828	806 314	257	524	023	5	5	2
530505	806 314	552	534	018	6,5	2	4
531566ZF	806 314	508	514	022	9	5	2
532826	806 314	257	514	023	5	5	2
532578ZF	806 314	141	524	014	9	5	2
532588ZF	806 314	141	524	016	9	5	2
532576ZF	806 314	141	514	014	9	5	2
532586ZF	806 314	141	514	016	9	5	2

Tool-kit for guided preparations of veneers. The depth-markers in combination with the guide-pin ensure a prep-depth of at least 0.4 mm. The tip surfaces of the cylindrical and tapered instruments with non-spherical but round tops enable chamfer-preparations up to 90°. With these tools esthetical, high-quality restorations become reality.

Kronentrenner Kit Crown cutter kit

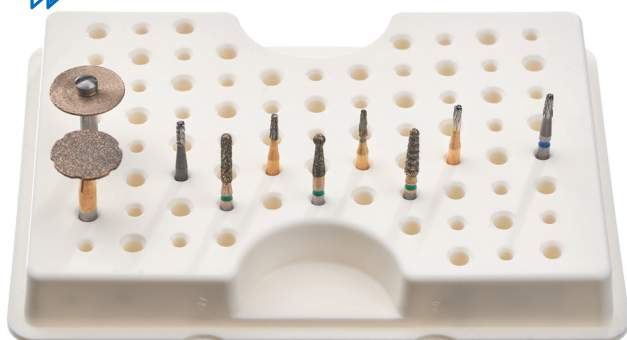

200132

Dieses Kit enthält Scheiben, Hartmetall- und Diamantinstrumente zum Trennen von Kronen und Brücken aus Lithiumdisilikat, Zirkon, Edelmetall, Nichtelegmetall, Titan und extraharten Kompositen. Ein einfaches und schnelles Entfernen von Zahnersatz, aus allen in der modernen Zahnmedizin verwendeten Materialien, wird somit ermöglicht. Der „SOFTY-longlife“ ist eine besonders schneidfreudige Sinterdiamantscheibe zum Trennen von Metallkronen ohne Verletzungsgefahr für die Gingiva (bitte Gebrauchshinweise beachten).

Bestell-Nr. Order number	ISO Nummer ISO number	Fig.Nr shape no.	Körnung grit	ø 1/10 mm ø 1/10 mm	KL mm hl mm	VE pu
940931	806 204	369	544	090	0,6	1
538055	806 314	141	534	014	8,5	2
534055S	806 314	005	534	016	6,5	2
534025Z	806 314	519	534	018	7,8	2
51141	807 204	345	523	100	0,4	1
411581	500 314	139	008	012	4,5	6
107512	500 314	168	060	012	4,5	6
107712	500 314	194	080	012	4,5	6
107912	500 314	137	075	012	6,0	6
109614	500 314	196	060	014	3,6	6

This kit contains diamond and carbide instruments as well as discs designed for cutting crowns in lithium disilicate, zirconia, precious and non-precious alloys, titanium and extra hard composites. Dental restorations made from all commonly used materials can be removed safely and rapidly. The "SOFTY-longlife" is a unique sintered diamond disc for separating metal crowns without risk of injury to the gingiva (please see instructions for use).

RTS
 Rotary Time System

1 1. Arbeitsgang: Finieren (15 - 30 Sek.)
1st step: finishing (15 - 30 sec.)

Ultra Light
 13 - 15 microns

Der spiralisierte FG Diamant
The spiral FG diamond



2 2. Arbeitsgang: Polieren (5 - 10 Sek.)
2nd step: polishing (5 - 10 sec.)

Uporal®
 1' - 3000 Upm/rpm 6 - 8 microns

Der dauerhafte Oralpolierer
The durable oral polisher

Geeignet für Komposit,
 Glas-Ionomere, Keramik
 und Amalgam.
 – Uporal® C und D.

*Suitable for composites,
 glas-ionomeres, ceramics
 and amalgam.*
 – Uporal® C and D.

Uporal® C
 (Metalle, Amalgam)
 (metals, amalgam)

Uporal® D
 (Komposit, Keramik, o.ä.)
 (composites, ceramics, etc.)

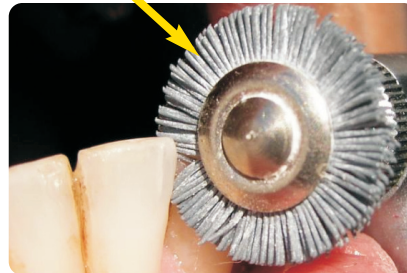

3 3. Arbeitsgang: Hochglanz (5 - 10 Sek.)
3rd step: high shine (5 - 10 sec.)

Diafix®-Oral
 1' - 3000 Upm/rpm 3 - 4 microns

Der Einmal-Hochglanz-
 Diamantpolierer
*The disposable diamond-
 impregnated polisher*

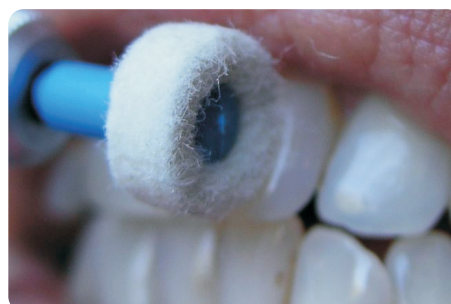

- ✓ Zeitgewinn
Fast results
- ✓ Exzellente Polierergergebnisse
Superior polishing results
- ✓ Kostenersparnis
Superior economics

Ultra-Light

ISO Nr.:
806 314 ...

Drehzahl / speed
30' - 300000 Upm / rpm

Fig.-Nr./shape no.	140	165	248	257
Ø 1/10 mm	010	014	014	023
KL/hl mm	6	8	6	4,5
Nachfüllpack / refills	2	2	2	2

504 superfein / superfine

532020 532100 532120 532040

1

Diese 4 Finierer decken alle restaurativen Arbeiten ab.

These 4 shapes are all you need for finishing restorative work.

Uporal® C + D

Nur 1' - 3000 Upm
1' - 3000 rpm only

Uporal® C
(mit Siliziumcarbid)
• Für Metall und Amalgam
For metals and amalgam
• Der ideale Prophylaxe Polierer
The ideal prophylaxis polisher
• ohne zusätzliche Paste
No polishing paste needed

Uporal® D
(mit Diadurit®)
• Härtere Faser, geeignet für Keramik, Composite, Compomere, Ceromere u.ä.
• *The tough fibre is most effective on ceramics, composites, compomers, ceromeres, and similar*

2

Diese Polierer reichen für alle Polierarbeiten aus. Spezialpolierer aus wasserabweisender Faser, mit Siliziumcarbid oder Diadurit® imprägniert und autoklavierbar bis 134° C.

These polishers are all you need for polishing restorations. Special polishers made of waterrepellent fibre, impregnated with silicon carbide or Diadurit®, autoclavable up to 134° C.

ISO Nr.:
653 204...
bis 10 - 20 sec
up to 10 - 20 sec
Drehzahl / speed
1000 - 3000 Upm / rpm

Fig.-Nr./shape no.	541	543	je 1 St.	541	542	165	542	je 1 St.
Ø 1/10 mm	070	135	1 pc each	070	045	135	045	1 pc each (cup/point)
Nachfüllpack / refills	2	2	set	2	2	2	2	set

492 ultrafein / ultrafine

800949 800939 800909 801989 801999 801979 802019 801909

Diafix®-Oral

ISO Nr.:
010 204 ...
bis 5 - 15 Sek
up to 5 - 15 sec
Drehzahl / speed
1000 - 3000 Upm / rpm

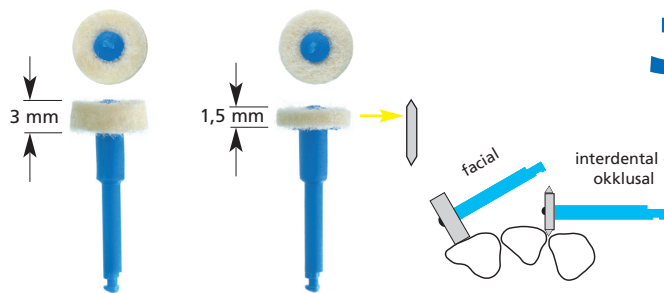

Fig.-Nr./shape no.	372	371
Ø 1/10 mm	090	090
KL/hl mm	3	1,5
Nachfüllpack / refills	12	12

sortiert je 6 St. assorted 6 pc each

491 ultrafein / ultrafine

80099 81099 82099

3

Zum Einmalgebrauch, nicht sterilisierbar!
Nur mit Desinfektions-Liquid behandeln! Diamant-imprägnierte (3-5 µm), montierte Filzpolierer mit Pfefferminz-Geschmack.

For single use only, not for sterilization!
Only treat with disinfectants! Felt polishers impregnated with diamonds (3-5µm), mounted, with peppermint flavor.

RTS-Intro-Set C

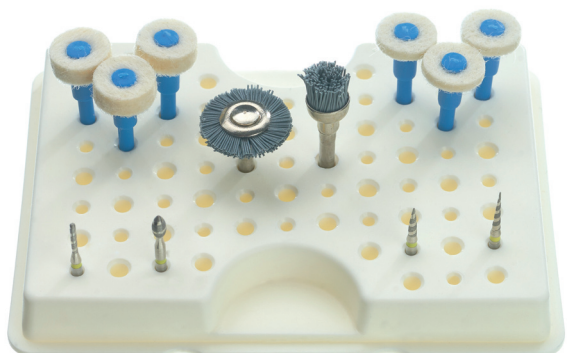

999000

RTS-Intro-Set C

- 12 Werkzeuge
12 instruments
- 1 Tray
1 tray

Polier-System für Metalle (Amalgam, NE-, CoCr-, Gold-, Platin-Legierungen, etc.) und zur Plaqueentfernung. Die extrem schnelle Bearbeitung durch **Uporal®** funktioniert effektiv und materialschonend, wenn vorher mit den spiralisierten **Ultra-Light-Diamanten** finiert wurde!

*Polishing system suitable for metals (amalgam, non-precious alloys including CoCr, gold and platinum alloys, and similar) and for plaque removal. For optimal performance using the **Uporal®**, finish in advance with the spiral-coated **Ultra-Light diamonds**.*

Bestell-Nr. Order number	ISO Nummer ISO number	Fig.Nr shape no.	Körnung grit	ø 1/10 mm ø 1/10 mm	VE pu
532020	806 314	140	504	010	2
532100	806 314	165	504	014	2
532040	806 314	243	504	022	2
532120	806 314	248	504	014	2
800949	653 204	541	492	070	2
800939	653 204	543	492	135	2
☒ 80099	010 204	372	491	090	12
☒ 81099	010 204	371	491	090	12

RTS-Intro-Set D

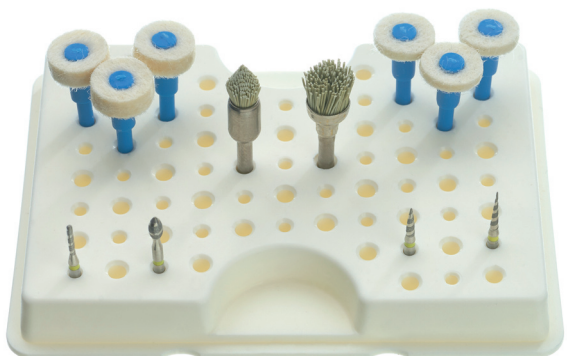

999002

RTS-Intro-Set D

- 12 Werkzeug
12 instruments
- 1 Tray
1 tray

Das erste Polier-System, das sich für viele Materialien eignet: Composite, Compomere, Polyglas, Ceromere, Keramik, Glas Ionomere u.ä. Die extrem schnelle Bearbeitung durch **Uporal®** funktioniert effektiv und materialschonend, wenn vorher mit den spiralisierten **Ultra-Light-Diamanten** finiert wurde!

*The first polishing system which is suitable for many materials: composites, compomeres, polyglas, ceromere, ceramics, glass ionomers and similar. For optimal performance using **Uporal®**, finish in advance with the spiral-coated **Ultra-Light diamonds**.*

Bestell-Nr. Order number	ISO Nummer ISO number	Fig.Nr shape no.	Körnung grit	ø 1/10 mm ø 1/10 mm	VE pu
532020	806 314	140	504	010	2
532100	806 314	165	504	014	2
532040	806 314	243	504	022	2
532120	806 314	248	504	014	2
801989	653 204	541	492	070	2
801999	653 204	542	492	045	2
☒ 80099	010 204	372	491	090	12
☒ 81099	010 204	371	491	090	12

Handyfix

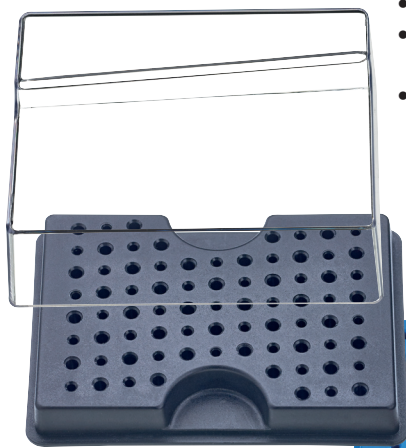

Best. Nr. 54000
Order No. 54000

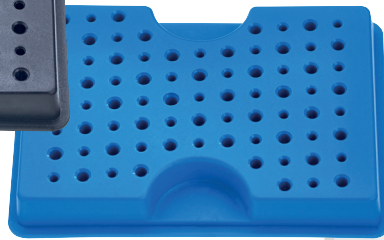

Best. Nr. 54002
Order No. 54002

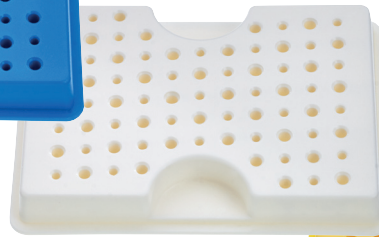

Best. Nr. 54001
Order No. 54001

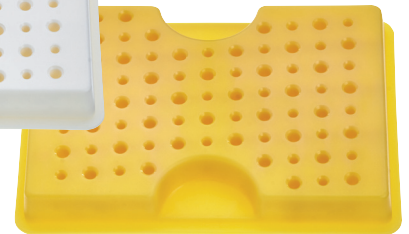

Best. Nr. 54003
Order No. 54003

Handyfix-Bohrerstände, einzeln

- 77 Steckplätze für 37 FGs + 40 WST s
- ohne Deckel thermisch belastbar bis 134°C
- 57 x 55 x 10 mm

Handyfix trays, single

- 77 slots for 37 FGs + 40 CA s
- thermal stability up to 134°C excluding cover
- 57 x 55 x 10 mm

Prophylaxe Polierer / Prophylaxis polishers

Das neue Poliersystem für die Prophylaxe

- ➔ leichte Handhabung
- ➔ beste Polierergebnisse
- ➔ materialsparend
- ➔ keine Polierpaste erforderlich

The new polishing system for prophylaxis

- ➔ easy to use
- ➔ excellent polishing results
- ➔ economical
- ➔ no polishing paste needed

Polierer auf mitgeliefertes Mandrell aufschrauben.

Screw polishers onto mandrel (included).

Drehzahl / speed

6000 Upm / rpm

ISO Nr.: 658 900 522 fein / fine



Fig.-Nr. / shape no.
Ø 1/10 mm
VE/pu

243
060
20 St. / 20 pcs
1 Mandrell / 1 mandrel

030
085
20 St. / 20 pcs
1 Mandrell / 1 mandrel

Sortiert / assorted
je 10 St. + 1 Mandrell
10 pcs each + 1 mandrel

Bestell-Nr.:
Order-No:

~~800108~~

~~800118~~

~~800128~~

2ceram Keramikpolierer 2-stufig 2ceram polishers for ceramics in 2 steps

Diamantierte Polierer zum Finieren, Polieren und Hochglanzpolieren für alle gängigen Keramiken.
Diamond-impregnated polishers for finishing, polishing and high-shine, suitable for all ceramics.

ISO Nr.: 803 204 514 superfein / superfine
803 204 524 fein / fine

Drehzahl / speed
6000 Upm / rpm

F :	243	030	304	243		243	030	304	243
d :	033	065	100	050		033	065	100	050
KL/hl :	7	9	6	10,5		7	9	6	10,5
Ps/ps :	1	1	1	1		2	2	2	2

Bestell-Nr.:
Order-No:

800616

800626

800636

800916

800646

800656

800666

800926

ISO Nr.: 803 314 514 superfein / superfine
803 314 524 fein / fine

F :	243	030		243	030
d :	033	060		033	060
KL/hl :	7	9		7	9
Ps/ps :	1	1		2	2

Bestell-Nr.:
Order-No:

803506

803516

803526

803536

2metal Polierer 2-stufig 2metal polishers in 2 steps

Abrasive Polierer für Edelmetall und Amalgam.
Abrasive polishers for precious alloys and amalgam.

ISO Nr.: 653 204 503 superfein / superfine
653 204 513 fein / fine

Drehzahl / speed
6000 Upm / rpm

F :	243	030	304	243		243	030	304	243
d :	033	065	100	050		033	065	100	050
KL/hl :	7	9	6	10,5		7	9	6	10,5
Ps/ps :	1	1	1	1		2	2	2	2

Bestell-Nr.:
Order-No:

800476

800486

800496

800406

800416

800426

800436

800446

Polierer sind zu 6 Stück verpackt.
F = ISO-Figur-Nr. · KL = Kopflänge in mm
d = Durchmesser in 1/10 mm · Ps = Polierstufe

Polishers are packed as 6 pieces.
F = ISO-Shape-No. · hl = head length in mm
d = diameter in 1/10 mm · ps = polishing step



2comp Kompositpolierer 2-stufig

2comp polishers for composites in 2 steps

Poliersystem in 2 Stufen für Komposite. Hochbeständiges Polyurethan mit Siliziumkarbid.
Silicone carbide impregnated polyurethane polishers for composites.

ISO Nr.: 653 204 511 superfein / *superfine*
 653 204 521 fein / *fine*

Drehzahl / *speed*
 6000 Upm / *rpm*

								
F :	243	030	304	243	243	030	304	243
d :	033	065	100	050	033	065	100	050
KL/hl :	7	9	6	10,5	7	9	6	10,5
Ps/ps :	1	1	1	1	2	2	2	2

Bestell-Nr.:
 Order-No:

800676

800686

800696

800806



800816

800826

800836

800846

ISO Nr.: 653 314 511 superfein / *superfine*
 653 314 521 fein / *fine*

		
F :	243	243
d :	033	033
KL/hl :	7	7
Ps/ps :	1	2

Bestell-Nr.:
 Order-No:

803546

803556









Durocomp Kompositpolierer 2-stufig

Durocomp polishers for composites in 2 steps

Diamantierte Polierer für extraharte Komposite mit überdurchschnittlicher Standzeit.
Long-lasting diamond impregnated polishers for extra-hard composites.

ISO Nr.: 022 204 504 superfein / *superfine*
 022 204 524 mittel / *medium*

Drehzahl / *speed*
 6000 Upm / *rpm*

								
F :	290	289	307	023	290	289	307	023
d :	050	033	100	060	050	033	100	060
KL/hl :	10,5	7	6	8,3	10,5	7	6	8,3
Ps/ps :	1	1	1	1	2	2	2	2

Bestell-Nr.:
 Order-No:

800559

800569

800579

800589

800759

800769

800779

800789

Polierer sind zu 6 Stück verpackt.
 F = ISO-Figur-Nr. · KL = Kopflänge in mm
 d = Durchmesser in 1/10 mm · Ps = Polierstufe

*Polishers are packed as 6 pieces.
 F = ISO-Shape-No. · hl = head length in mm
 d = diameter in 1/10 mm · ps = polishing step*

Chirurgie: Instrumente aus gehärtetem, rostbeständigem Stahl

Surgical burs: hardened stainless steel bone cutters

(nach/according to Prof. Dr. Lindemann)

Drehzahl/speed FG - 100000 Upm/rpm
 WST/CA - 40000 Upm/rpm
 HST/HP - 40000 Upm/rpm

ISO Nr.: 330 ...

Fig.-Nr./shape no.
 Ø 1/10 mm
 Verzahnung/cut
 KL/hl

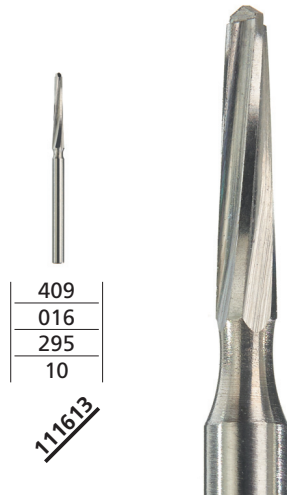

409
016
295
10

315 FG L

Typ 161

111613

ISO Nr.: 330 ...

Fig.-Nr./shape no.
 Ø 1/10 mm
 Verzahnung/cut
 KL/hl



408
016
297
9

315 FG L

Typ I

110013



408
022
297
8

205 WST L / CA L

Typ 165

111654



ISO Nr.: 330 ...

Fig.-Nr./shape no.
 Ø 1/10 mm
 Verzahnung/cut
 KL/hl



409
016
297
10

315 FG L

Typ 162

111623

Typ II

409
014
297
10

205 WST L / CA L

Typ 162

111624

104 HST / HP

Typ 162

111622

110023



Knochenfräser sind zu 2 Stück verpackt.
 Fig.-Nr. = ISO-Figur-Nr. · KL = Kopflänge in mm

Bone cutters are packed as 2 pieces.
 shape no. = ISO-Shape-No. · hl = head length in mm

Chirurgie: Instrumente aus gehärtetem, rostbeständigem Stahl

Surgical burs: hardened stainless steel bone cutters

(nach/according to Prof. Dr. Lindemann)

Drehzahl/speed FG - 100000 Upm/rpm
 WST/CA - 40000 Upm/rpm
 HST/HP - 40000 Upm/rpm

ISO Nr.: 330 ...

Fig.-Nr./shape no.
 Ø 1/10 mm
 Verzahnung/cut
 KL/hl



411
016
297
13

315 FG L

Typ III

110033



411
020
297
12

Typ 166

111664



411
022
297
12

Typ 167

111674

205 WST L / CA L



Chirurgie: Instrumente aus gehärtetem, rostbeständigem Stahl mit Spezialbeschichtung für eine lange Standzeit

Surgical burs: hardened stainless steel bone cutters with special coating for extra long lifetime

Drehzahl/speed WST/CA - 40000 Upm/rpm

ISO Nr.: 336 ...

Fig.-Nr./shape no.
 Ø 1/10 mm
 Verzahnung/cut
 KL/hl



411
021
338
13,2

205 WST L / CA L

110154



411
021
338
18,5

206 WST XL / CA XL

110164



411
026
338
14

110134



411
026
338
19

110144



Knochenfräser sind zu 2 Stück verpackt.
 Fig.-Nr. = ISO-Figur-Nr. · KL = Kopflänge in mm

Bone cutters are packed as 2 pieces.
 shape no. = ISO-Shape-No. · hl = head length in mm

Chirurgie: Knochenfräser aus Hartmetall / Surgery: carbide bone cutters

Drehzahl / speed









FG - 100000 Upm / rpm

WST/CA - 40000 Upm / rpm

HST / HP - 40000 Upm / rpm

ISO Nr.: 500 ...

Fig.-Nr./shape no.
Ø 1/10 mm
Verzahnung / cut
KL/hl

								
001	001	001	001	001	001	001	001	001
014	018	023	025	031	035	040	050	
291	291	291	291	291	291	291	291	
-	-	-	-	-	-	-	-	

205 WST L / CA L

104 HST / HP

110126
110127
110128
110115
110120
110116
110121
110117
110118
110119
110122

ISO Nr.: 500 ...

Fig.-Nr./shape no.
Ø 1/10 mm
Verzahnung / cut
KL/hl

		
001	170	001
023	016	023
006	296	006
-	5,5	-



105 HST L / HP L

111197
111198
117023XL



ISO Nr.: 500 ...

Fig.-Nr./shape no.
Ø 1/10 mm
Verzahnung / cut
KL/hl

	
170	408
016	016
008	295
4,5	10

105 HST L / HP L

109316XL
110324

Chirurgie: Knochenfräser aus Hartmetall / Surgery: carbide bone cutters

Drehzahl / speed

FG - 100000 Upm / rpm

WST/CA - 40000 Upm / rpm

HST / HP - 40000 Upm / rpm





ISO Nr.: 500 ...

Fig.-Nr./shape no.	408	410	408	408	410	409
Ø 1/10 mm	016	016	016	016	016	016
Verzahnung / cut	297	298	298	298	298	297
KL/hl	9	11	9,5	9,5	11	10

315 FG L

316 FG XL Typ C 162

104 HST / HP

110314
110318
110316
110317
110319
110213

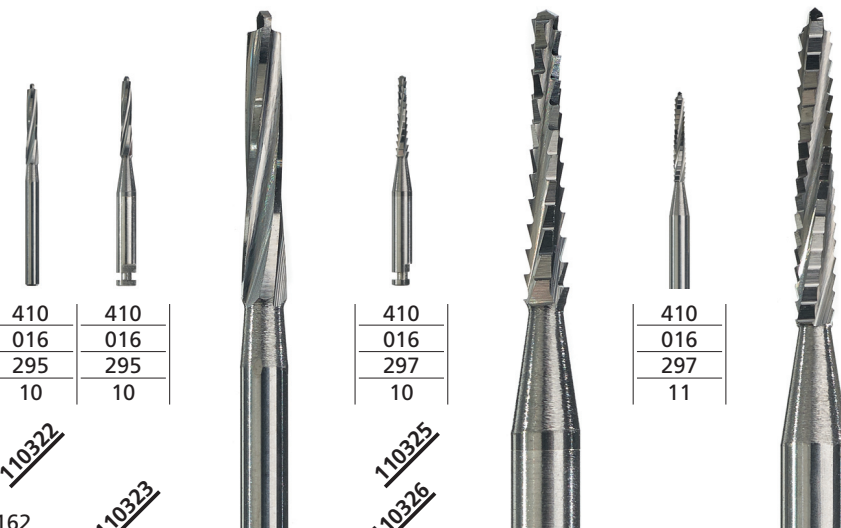

ISO Nr.: 500 ...

Fig.-Nr./shape no.	410	410	410	410	410
Ø 1/10 mm	016	016	016	016	016
Verzahnung / cut	295	295	297	297	297
KL/hl	10	10	10	10	11

316 FG XL Typ C 162

205 WST L / CA L Typ C 162

104 HST / HP Typ C 162

110322
110323
110325
110326
110327
110315

Knochenfräser sind zu 2 Stück verpackt.
Fig.-Nr. = ISO-Figur-Nr. · KL = Kopflänge in mm

Bone cutters are packed as 2 pieces.
shape no. = ISO-Shape-No. · hl = head length in mm

Chirurgie: Knochenfräser aus Hartmetall / Surgery: carbide bone cutters

Drehzahl / speed

FG - 100000 Upm / rpm
 WST/CA - 40000 Upm / rpm
 HST / HP - 40000 Upm / rpm

Carboss/
Carboss

ISO Nr.: 500 ...

Fig.-Nr./shape no.
 Ø 1/10 mm
 Verzahnung/cut
 KL/hl

192
016
018
8



204 WST / CA Typ C 184

110184

ISO Nr.: 500 ...

Fig.-Nr./shape no.
 Ø 1/10 mm
 Verzahnung/cut
 KL/hl

410
016
297
10



315 FG L Typ C168

110093

205 WST L / CA L

104 HST / HP

598
023
008
11



111098

111097

ISO Nr.: 500 ...

Fig.-Nr./shape no.
 Ø 1/10 mm
 Verzahnung/cut
 KL/hl

687
016
133
10



205 WST L / CA L Typ C 687

111200

ISO Nr.: 500 ...

Fig.-Nr./shape no.
 Ø 1/10 mm
 Verzahnung/cut
 KL/hl

687
023
297
11



205 WST L / CA L Typ C 687X

111220

ISO Nr.: 500 ...

Fig.-Nr./shape no.
 Ø 1/10 mm
 Verzahnung/cut
 KL/hl

534
012
023
6



315 FG L

Typ CB 255A

111413

316 FG XL

Typ CB 255A

111423

Chirurgie: Knochenfräser aus Hartmetall / Surgery: carbide bone cutters

Drehzahl / speed

FG - 100000 Upm / rpm
 WST/CA - 40000 Upm / rpm
 HST / HP - 40000 Upm / rpm

ISO Nr.: 500 ...

Fig.-Nr. / shape no.	219
Ø 1/10 mm	015
Verzahnung / cut	295
KL/hl	9

314 FG Typ C 152

110125

316 FG XL Typ C 152

110123

204 WST / CA Typ C 152

110124

ISO Nr.: 500 ...

Fig.-Nr. / shape no.	199
Ø 1/10 mm	015
Verzahnung / cut	336
KL/hl	11

316 FG XL Typ C 151

110113

205 WST L / CA L Typ C 151

110114

ISO Nr.: 500 ...

Fig.-Nr. / shape no.	409	409	410
Ø 1/10 mm	021	023	023
Verzahnung / cut	297	297	297
KL/hl	9	9	10

204 WST / CA

110094

205 WST L / CA L

110095

104 HST / HP

110096

121718

121721

121723

Knochenfräser SET

Bestell-Nr.: 800211

- Inhalt:
- 110094 (1 Stück)
- 110095 (1 Stück)
- 110096 (1 Stück)
- 111675 (1 Stück)

Bone cutter kit

Order-no.: 800211

- Content:
- 110094 (1 pc)
- 110095 (1 pc)
- 110096 (1 pc)
- 111675 (1 pc)



ISO Nr.: 500 ...

Fig.-Nr. / shape no.	415	415
Ø 1/10 mm	012	012
Verzahnung / cut	298	298
KL/hl	5,5	5,5

316 FG XL

110320

317 FG XXL

110313

205 WST L / CA L

110311

110312

Knochenfräser sind zu 2 Stück verpackt.
 Fig.-Nr. = ISO-Figur-Nr. · KL = Kopflänge in mm

Bone cutters are packed as 2 pieces.
 shape no. = ISO-Shape-No. · hl = head length in mm

DIADOSS: Diamantierte Knochenfräser aus rostbeständigem Stahl

DIADOSS: Diamond coated bone cutters in stainless steel

Drehzahl / speed

FG - 100000 Upm / rpm

Diamantierte Knochenfräser für den Härtefall.

Diamond bone-cutters for ultra-tough applications.



Fig.-Nr. / shape no.	411	411	411
Ø 1/10 mm	016	018	021
KL/hl	11	11	11
VE/ps	2	2	2

315 FG L

121613

121623

121633

ENDO Instrumente / Endodontic instruments

ISO Nr.: 506 ...

Drehzahl / speed

FG - 100000 Upm / rpm



Fig.-Nr. / shape no.
Ø 1/10 mm
Verzahnung / cut
KL/hl

315	315
012	014
006	006
9	9

316 FG XL Typ C 389

116110

116112



Hartmetallkopf mit Verzahnung.
Carbide head with cutting blades.

Diamantierung.
Diamond coating.

Diamantierte Hartmetallfräser für Endo / Zugangskavitäten.
Diamond coated carbide endo access burs.

ISO Nr.: 806 534 grob / coarse

Drehzahl / speed

FG -300000 Upm / rpm



Fig.-Nr. / shape no.
Ø 1/10 mm
KL/hl

219
014
9

313 FG kurz / short

314 FG

538165

538265



494
018
10

538275

Diamantierte Instrumente.
Diamond coated instruments.

Alle Instrumente sind zu 2 Stück verpackt.
Fig.-Nr. = ISO-Figur-Nr. · KL = Kopflänge in mm

All instruments are packed as 2 pieces.
shape no. = ISO-Shape-No. · hl = head length in mm

Spezialwerkzeuge für die Zirkonbearbeitung / *Special instruments for zirconia*

1. Schleifen / Grinding



**ZIRKONDIAMANTEN
ZIRCONIA DIAMONDS**
806 314
15' - 300000 Upm/rpm

ISO Nr.:	198	298	257	257
Drehzahl/speed	514	514	514	514
Fig.-Nr. / shape no.	018	014	018	023
Körnung/grain	8,0	8,0	4,5	5,0
Ø 1/10 mm	5	5	5	5
KL/hl mm				
VE/pu				

531516Z
532216Z
532816Z
539356

2. Finieren / Finishing



CIRCOPOL N
803 314
- 15000 Upm/rpm

243	243
534	514
050	050
10,5	10,5
1	1

80028
80029

3. Hochglanz / High-Shine



DIAFIX®-Oral
010 204
1000 - 3000 Upm/rpm

372
491
090
3
12

80099

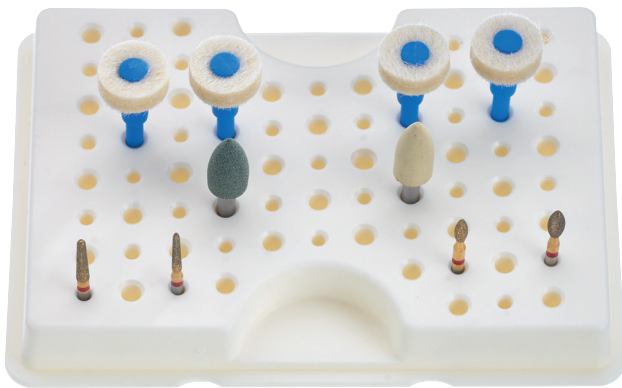

800209

Bestell-Nr. Order number	ISO Nummer ISO number	Fig.Nr shape no.	Körnung grit	ø 1/10 mm ø 1/10 mm	VE pu
531516Z	806 314	198	514	018	5
532216Z	806 314	298	514	014	5
532816Z	806 314	257	514	018	5
539356	806 314	257	514	023	2
80028	803 314	243	534	050	1
80029	803 314	243	514	050	1
80092	010 204	372	491	090	12

Nach dem Beschleifen des Zirkons mit Diamanten (mit Kühlung) die beiden Circopol N Instrumente (mit Kühlung) sequenziell applizieren, um anschließend mit Diafix®-Oral (ohne Kühlung) den absoluten Hochglanz zu erzielen.

After grinding with diamonds (water cooling), apply both Circopol N instruments (water cooling) sequentially. Finish Diafix®-Oral (without water cooling) for perfect high-shine.

Trepanierer Zirkon / *Instrument for trepanating zirconia*

ISO Nr.: 806 314 F 534 grob / coarse

Drehzahl / speed
- 300000 Upm / rpm

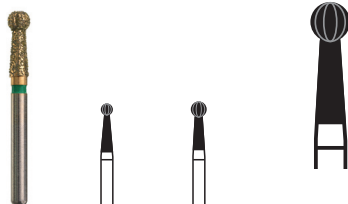

Fig.-Nr. / shape no.	005	005
Ø 1/10 mm	016	021
KL/hl mm	6,5	6,5
VE/pu	2	2

5340555
534055

Spezialinstrument zur Trepanation von vollkeramischen Kronen, insbesondere Zirkon.
Formgestaltung und Diamantierung wurden speziell für Zirkon und Vollkeramik entwickelt.
Auf ausreichende Wasserkühlung achten!

*Instrument for trepanating full-ceramic crowns, especially zirconia.
Shape, design and diamond coating were specially developed for full ceramics, especially zirconia.
Ensure sufficient water cooling!*

FG Diamanten für die Zirkonbearbeitung / FG diamonds for zirconia

ISO Nr.: 806 314 F **504** superfein / *superfine*
 806 314 F **514** fein / *fine*
 806 314 F **524** mittel / *medium*
 806 314 F **534** grob / *coarse*

Drehzahl / *speed*
 30' - 300000 Upm / *rpm*



801	F:	001	001
	d:	014	018
	KL/hl:	-	-
	P:	1	1
	VE/pu:	5	5



881	F:	141	
	d:	014	
	KL/hl:	8,5	
	P:	1	
	VE/pu:	5	

856	F:	198	198
	d:	016	018
	KL/hl:	8	8
	P:	1	1
	VE/pu:	5	5

530028Z

530048Z

532576Z

532575Z

531506MZ

531508MZ

531514Z

531516Z



368	F:	257	257
	d:	018	023
	KL/hl:	4,5	5
	P:	2	2
	VE/pu:	5	5

390	F:	274	
	d:	016	
	KL/hl:	3,5	
	P:	1	
	VE/pu:	5	

379	F:	277	
	d:	018	
	KL/hl:	5	
	P:	1	
	VE/pu:	5	

532814Z

532816Z

532826Z

532828Z

533006MZ

533008MZ

532914Z

532916Z

878K	F:	298	
	d:	014	
	KL/hl:	8	
	P:	1	
	VE/pu:	5	

532214Z

532216Z

F = ISO-Figur-Nr. · KL = Kopflänge in mm
 d = Durchmesser in 1/10 mm · P = Preiskategorie

F = ISO-Shape-No. · hl = head length in mm
 d = diameter in 1/10 mm · P = price category

Kronentrenner Zirkon / Crown cutter zirconia

ISO Nr.: 806 314 F 534 grob / coarse

Drehzahl / speed
30' - 300000 Upm / rpm

Fig.-Nr. / shape no.
Ø 1/10 mm
KL/hl mm
VE/pu

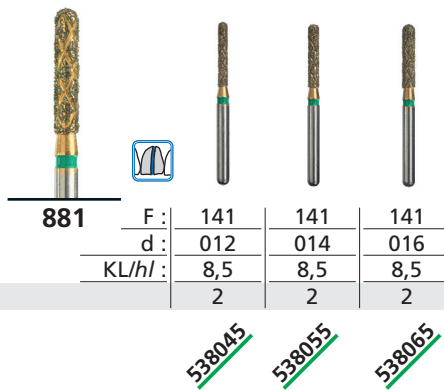

ISO Nr.: 806 314 F 534 grob / coarse

Drehzahl / speed
30' - 300000 Upm / rpm

Fig.-Nr. / shape no.
Ø 1/10 mm
KL/hl mm
VE/pu

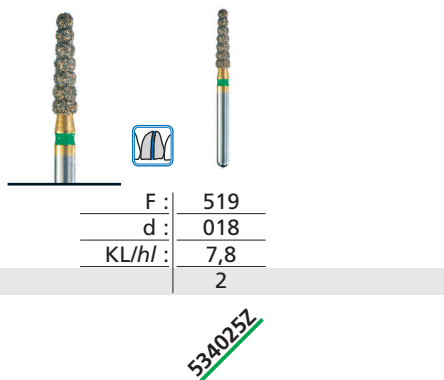

Zircut® – Kronentrenner für Vollkeramik und Zirkon Zircut® – Crown cutter for ceramics and zirconia

ISO Nr.: 806 ...

Drehzahl / speed
15' - 25000 Upm / rpm



Fig.-Nr. / shape no.	369	369	369	369
Ø 1/10 mm	070	070	090	090
KL/hl mm	0,6	0,6	0,6	0,6
VE/pu	1	1	1	1

204 WST / CA

104 HST / HP

9A0704

9A0702

9A0931

9A0933

Die Zircut® Scheibe dient zum Trennen aller vollkeramischen Kronen und Brücken, insbesondere aus Zirkon. Extrem hohe Schneideffizienz, mehrfach verwendbar, Standzeit bei korrekter Anwendung 15-25 Kronen. Das Design und die Diamantierung des Zircut® sind auf optimierte Kühlung ausgelegt, wodurch das Risiko einer Pulpa-Schädigung aufgrund von Hitzeentwicklung während des Trennvorgangs vermieden werden kann. Achtung: Kontakt mit Weichgewebe ist unbedingt zu vermeiden, Verletzungsgefahr! Ausreichend Wasserkühlung erforderlich.

Specially designed diamond-coated disc for separating full-ceramic crowns and bridges, especially zirconia. Extremely high cutting efficiency, will cut 15-25 crowns if used correctly. Design and diamond coating optimized to ensure maximum cooling effect so that damage to the pulpa due to excessive heat while cutting can be avoided. Warning: contact with soft tissue must be avoided, risk of injury! Water cooling required.

Kronentrenner „SOFTY-longlife“ Crown Cutter „SOFTY-longlife“

ISO Nr.: 807 ... 523 ...

Drehzahl / speed
15' - 20000 Upm / rpm



Fig.-Nr./shape no.
Ø 1/10 mm
KL/hl mm
VE / pu

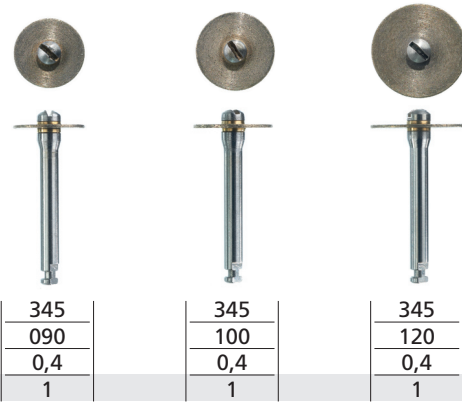

345	345	345
090	100	120
0,4	0,4	0,4
1	1	1

204 WST / CA

104 HST / HP

51143

51141

51145

50143

50141

50145

Weichschneidende Sinterdiamant-scheibe zum Trennen von Kronen und Brücken. Bei korrektem Gebrauch keine Verletzung der Gingiva! 1 Scheibe ist ausreichend zum Trennen von ca.15-20 Kronen! Nur mit ausreichend Wasserkühlung einsetzen!

Soft cutting sintered diamond disc for separating crowns and bridges. If used correctly it will not injure soft tissue! 1 disc sufficient for approximately 15-20 crowns! Use only with sufficient water cooling!

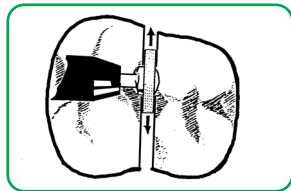

Richtige Anwendung des Crown Cutters.
Correct use of the crown cutter.

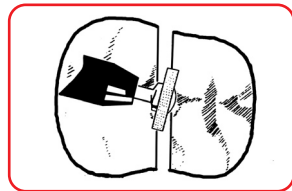

Falsche Anwendung des Crown Cutters, kein Verkanten beim Trennen.
Incorrect use of the crown cutter, don't tilt the disc during cutting.

Wunderkugel / Wonder Ball

ISO Nr.: 806 314 F 524

Drehzahl / speed
30' - 300000 Upm / rpm



Seitenansicht
Schneiden
*Lateral view
of cutting edge*



F :	001
d :	016
KL/hl :	-
VE :	1













534068

Zum Entfernen alter Füllungen, wie Amalgam und Komposit. Mit diesem diamantierten Werkzeug ist ein Bohren und gleichzeitiges seitliches Schleifen möglich.









To remove old fillings like amalgam and composite. Simultaneous drilling and collateral grinding is possible with this diamond instrument.

Hartmetallinstrumente / Carbide burs







Kario Cut ISO No: 500
Rosehead burs Cut: 006

												
1	F :	001	001	001	001	001	001	001	001	001	001	001
	d :	005	006	008	010	012	014	016	018	021	023	027
Upm / rpm	KL/hl :	-	-	-	-	-	-	-	-	-	-	-
FG - 300000 WST/CA - 20000	US-Code :	1/4	1/2	1	2	3	4	5	6	7	8	9
314 FG		<u>117605</u>	<u>117606</u>	<u>117608</u>	<u>117610</u>	<u>117612</u>	<u>117614</u>	<u>117616</u>	<u>117618</u>	<u>117621</u>	<u>117623</u>	
316 FG XL				<u>117608-L</u>	<u>117610-L</u>	<u>117612-L</u>	<u>117614-L</u>	<u>117616-L</u>	<u>117618-L</u>	<u>117621-L</u>	<u>117623-L</u>	
317 FG XXL					<u>117610XL</u>							
204 WST/CA		<u>117505</u>	<u>117506</u>	<u>117508</u>	<u>117510</u>	<u>117512</u>	<u>117514</u>	<u>117516</u>	<u>117518</u>	<u>117521</u>	<u>117523</u>	<u>117527</u>

Kario Longcut ISO No: 500
Rosehead burs long Cut: 006

								
1L	F :	001	001	001	001	001	001	001
	d :	010	012	014	016	018	021	023
Upm / rpm	KL/hl :	-	-	-	-	-	-	-
WST/CA - 20000	US-Code :	2	3	4	5	6	7	8
205 WST-L/CA-L		<u>117510-L</u>	<u>117512-L</u>	<u>117514-L</u>	<u>117516-L</u>	<u>117518-L</u>	<u>117521-L</u>	<u>117523-L</u>

Kario Cut D ISO No: 500
Rosehead burs D Cut: 009

					
1	F :	001	001	001	001
	d :	014	016	018	021
Upm / rpm	KL/hl :	-	-	-	-
WST/CA - 20000	US-Code :	4	5	6	7
204 WST/CA		<u>117514D</u>	<u>117516D</u>	<u>117518D</u>	<u>117521D</u>

Diamantierte Hartmetallinstrumente
 Diamond-coated carbide instruments



Hartmetallinstrumente sind zu 6 Stück verpackt.
 F = ISO-Figur-Nr. · d = Durchmesser in 1/10 mm
 KL = Kopflänge in mm

Carbide burs are packed as 6 pieces.
 F = ISO-Shape-No. · d = diameter in 1/10 mm
 hl = head length in mm

Hartmetallinstrumente / Carbide burs

Kario Cut ISO No: 500
Rosehead burs Cut: 009



1	F :	001	001	001	001	001	001	001
	d :	010	012	014	016	018	021	023
	KL/hl :	-	-	-	-	-	-	-
	US-Code :	2X	3X	4X	5X	6X	7X	8X

U_{pm}/rpm
WST/CA - 20000

204 WST/CA

205 WST-L/CA-L

117510RS
117510SL
117512RS
117512SL
117514RS
117514SL
117516RS
117516SL
117518RS
117518SL
117521RS
117521SL
117523RS
117523SL

ISO No: 500
Cut: 006



2	F :	010	010	010	010	010	010
	d :	008	010	012	014	016	018
	KL/hl :	1,2	1,2	1,5	1,8	2,0	2,2
	US-Code :	34	35	36	37	38	39

U_{pm}/rpm
FG - 300000
WST/CA - 50000

314 FG
204 WST/CA

102608
102508
102610
102510
102612
102512
102614
102514
102616
102516
102618
102518

ISO No: 500
Cut: 006



7	F :	237	237	237
	d :	008	010	012
	KL/hl :	2,5	2,5	2,5
	US-Code :	330	331	332

U_{pm}/rpm
FG - 300000
WST/CA - 50000

314 FG
313 FG short
204 WST/CA

102108
102208
102110
102112

ISO No: 500
Cut: 006



7L	F :	234	234
	d :	010	014
	KL/hl :	3,3	3,3
	US-Code :	331L	333L

U_{pm}/rpm
FG - 300000

314 FG

105010
105014

ISO No: 500
Cut: 006



21	F :	107	107	107	107	107
	d :	009	010	012	014	016
	KL/hl :	4,0	4,5	4,5	5,0	5,0
	US-Code :	56	57	58	59	60

U_{pm}/rpm
FG - 300000
WST/CA - 50000

314 FG
204 WST/CA

102309
102410
102310
102412
102312
102414
102314
102316

Hartmetallinstrumente sind zu 6 Stück verpackt.
 F = ISO-Figur-Nr. · d = Durchmesser in 1/10 mm
 KL = Kopflänge in mm

Carbide burs are packed as 6 pieces.
 F = ISO-Shape-No. · d = diameter in 1/10 mm
 hl = head length in mm

Hartmetallinstrumente / Carbide burs

ISO No: 500
Cut: 006



F:	110	110
d:	010	012
KL/hl:	6,0	6,0
US-Code:	57L	58L

U_{pm} / r_{pm}
FG - 300000

314 FG

102710
102712

Amal Cut ISO No: 500
Cut: 006



F:	137	137	137
d:	009	010	012
KL/hl:	3,3	4,0	4,0
US-Code:	1156	1157	1158

U_{pm} / r_{pm}
FG - 300000

314 FG

103009
103010
411580

ISO No: 500
Cut: 006



F:	168	168	168
d:	009	010	012
KL/hl:	5,0	5,0	5,0
US-Code:	169	170	171

U_{pm} / r_{pm}
FG - 300000

314 FG

103209
103210
103212

ISO No: 500
Cut: 006



F:	171	171	171
d:	009	010	012
KL/hl:	5,5	5,5	5,5
US-Code:	169L	170L	171L

U_{pm} / r_{pm}
FG - 300000
WST/CA - 50000

314 FG
204 WST/CA

103309
103509
103310
103312

ISO No: 500
Cut: 006



F:	194	194	194
d:	010	012	016
KL/hl:	5,0	5,0	5,0
US-Code:	1170	1171	1172

U_{pm} / r_{pm}
FG - 300000
WST/CA - 50000

314 FG
204 WST/CA

103410
103412
103416
103516

ISO No: 500
Cut: 006



F:	238	238
d:	010	012
KL/hl:	5,5	5,5
US-Code:	331L	332L

U_{pm} / r_{pm}
FG - 300000

314 FG

103610
103612

Hartmetallinstrumente sind zu 6 Stück verpackt.
F = ISO-Figur-Nr. · d = Durchmesser in 1/10 mm
KL = Kopflänge in mm

Carbide burs are packed as 6 pieces.
F = ISO-Shape-No. · d = diameter in 1/10 mm
hl = head length in mm

Hartmetallinstrumente / Carbide burs

ISO No: 500
Cut: 008

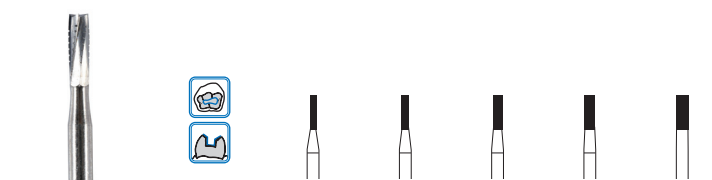

31	F :	109	109	109	109	109
	d :	008	010	012	014	016
U_{pm}/rpm	KL/hl :	4,5	4,5	4,5	4,5	4,5
FG - 300000	US-Code :	556	557	558	559	560

314 FG
316 FG XL

103708
103710
103810
103812
103714
103716

ISO No: 500
Cut: 008

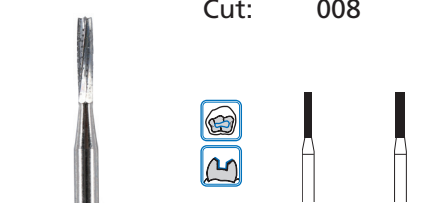

31L	F :	110	110
	d :	010	012
U_{pm}/rpm	KL/hl :	6,0	6,0
FG - 250000	US-Code :	557L	558L

314 FG

104010
104012

ISO No: 500
Cut: 008

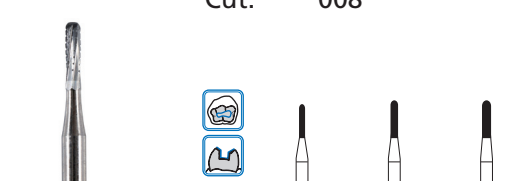

31R	F :	137	137	137
	d :	008	010	012
U_{pm}/rpm	KL/hl :	4,5	4,0	5,0
FG - 300000	US-Code :	1556	1557	1558

314 FG

104308
104310
104312

ISO No: 500
Cut: 008

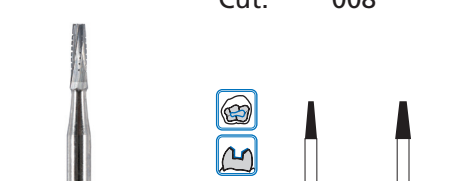

33	F :	168	168
	d :	016	021
U_{pm}/rpm	KL/hl :	5,0	5,0
FG - 300000	US-Code :	702	703

314 FG
316 FG XL

104516
104616
104521

ISO No: 500
Cut: 008

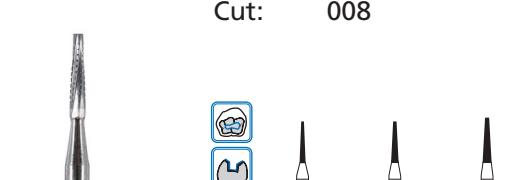

33L	F :	171	171	171
	d :	008	010	012
U_{pm}/rpm	KL/hl :	5,5	5,5	6,0
FG - 300000	US-Code :	699L	700L	701L

314 FG



104608
104610
104612

Hartmetallinstrumente sind zu 6 Stück verpackt.
F = ISO-Figur-Nr. · d = Durchmesser in 1/10 mm
KL = Kopflänge in mm

Carbide burs are packed as 6 pieces.
F = ISO-Shape-No. · d = diameter in 1/10 mm
hl = head length in mm

Hartmetallinstrumente / Carbide burs

ISO No: 500
Cut: 008



F :	194
d :	012
KL/hl :	5,0
US-Code :	1701

33R

Upm/rpm
FG - 300000

314 FG **104812**

ISO No: 500
Cut: 072



F :	198
d :	014
KL/hl :	8,0
US-Code :	7664

375

Upm/rpm
FG - 250000

314 FG **109714**

ISO No: 500
Cut: 006

F :	233
d :	008
KL/hl :	3
US-Code :	245



245

Upm/rpm
FG - 300000

314 FG **104908**

Hartmetallfinierer / Carbide finishing burs

ISO No: 500
Cut: 042



F :	001	001	001
d :	014	018	023
KL/hl :	-	-	-
US-Code :	7004	7006	7008

41

Upm/rpm
FG - 300000

314 FG **106014** **106018** **106023**

ISO No: 500
Cut: 042

F :	277	277	277
d :	014	018	023
KL/hl :	3,5	4,0	4,0
US-Code :	7404	7406	7408

44E

Upm/rpm
FG - 300000

314 FG **106114** **106118** **106123**

204 WST/CA

Hartmetallinstrumente sind zu 6 Stück verpackt.
F = ISO-Figur-Nr. · d = Durchmesser in 1/10 mm
KL = Kopflänge in mm

Carbide burs are packed as 6 pieces.
F = ISO-Shape-No. · d = diameter in 1/10 mm
hl = head length in mm

Hartmetallfinierer / Carbide finishing burs

ISO No: 500
Cut: 042

46	F :	254	254	254
	d :	014	018	023
U _{pm} / r _{pm}	KL/hl :	3,5	4,0	5,0
FG - 300000	US-Code :	7104	7106	7108

314 FG

106414 *106418* *106423*



ISO No: 500
Cut: 075

47L	F :	236
	d :	014
U _{pm} / r _{pm}	KL/hl :	4,3
FG - 300000	US-Code :	7304

314 FG

106414L

ISO No: 500
Cut: 072

48	F :	246	246	246
	d :	008	010	012
U _{pm} / r _{pm}	KL/hl :	4,0	4,0	4,5
FG - 300000	US-Code :	7901	7902	7903

314 FG

106508 *106510* *106512*

ISO No: 500
Cut: 071

132	F :	267
	d :	008
U _{pm} / r _{pm}	KL/hl :	3,0
FG - 300000	US-Code :	7114

314 FG

106708

ISO No: 500
Cut: 041

133	F :	217
	d :	010
U _{pm} / r _{pm}	KL/hl :	6,0
FG - 300000	US-Code :	7214

314 FG

106810

ISO No: 500
Cut: 041

135	F :	184
	d :	014
U _{pm} / r _{pm}	KL/hl :	9,5
FG - 300000	US-Code :	7714

314 FG

106914

Hartmetallinstrumente sind zu 6 Stück verpackt.
F = ISO-Figur-Nr. · d = Durchmesser in 1/10 mm
KL = Kopflänge in mm

Carbide burs are packed as 6 pieces.
F = ISO-Shape-No. · d = diameter in 1/10 mm
hl = head length in mm

Hartmetallfinierer / Carbide finishing burs

ISO No: 500
Cut: 042

212

F :	168	168
d :	010	012
KL/hl :	5,5	5,5
US-Code :	7702	7713

U_{pm}/r_{pm}
FG - 300000

314 FG

107010 *107012*

ISO No: 500
Cut: 042

212L

F :	184	184	184
d :	014	016	018
KL/hl :	9,5	9,5	9,5
US-Code :	7204	7205	7206

U_{pm}/r_{pm}
FG - 300000

314 FG

107114 *107116* *107118*

ISO No: 500
Cut: 042

247

F :	499	499	499
d :	008	010	012
KL/hl :	3,5	3,5	4,0
US-Code :	7801	7802	7803

U_{pm}/r_{pm}
FG - 300000

314 FG

107308 *107310* *107312*

ISO No: 500
Cut: 042

212 UF

F :	168
d :	012
KL/hl :	5,5
US-Code :	9713

U_{pm}/r_{pm}
FG - 300000

314 FG

107212

ISO No: 500
Cut: 032

247 UF

F :	499
d :	012
KL/hl :	4,0
US-Code :	9803

U_{pm}/r_{pm}
FG - 300000

314 FG

107412

ISO No: 500
Cut: 032

44E UF

F :	277
d :	018
KL/hl :	4,0
US-Code :	9406

U_{pm}/r_{pm}
FG - 300000

314 FG

106318

ISO No: 500
Cut: 032

48 UF

F :	247	247
d :	012	014
KL/hl :	6,0	6,0
US-Code :	9903	9904

U_{pm}/r_{pm}
FG - 300000

314 FG

106612 *106614*

Hartmetallinstrumente sind zu 6 Stück verpackt.
F = ISO-Figur-Nr. · d = Durchmesser in 1/10 mm
KL = Kopflänge in mm



Carbide burs are packed as 6 pieces.
F = ISO-Shape-No. · d = diameter in 1/10 mm
hl = head length in mm

Kronentrenner Hartmetall / Crown cutters carbide

Trennen von EM, NE, Titan sowie extraharten Kompositen.

Cutting of precious, non-precious and titanium crowns and bridges as well as extrahard composites.

ISO No: 500
Cut: 137

Crown Cutter Carbide FG



F :	139
d :	012
KL/hl :	4,5
US-Code :	58RX

U_{pm} / rpm
FG - 300000

314 FG **411581**



ISO No: 500
Cut: 137

Crown Cutter Carbide FG

F :	196
d :	012
KL/hl :	4,5
US-Code :	71RX

U_{pm} / rpm
FG - 300000





314 FG **411582**



Trennen von EM, NE, Titan, Kronen und Brücken inkl. VMK.

Cutting of precious, non-precious and titanium crowns and bridges incl. PFM.

ISO No: 500
Cut: 060

23X



F :	168	168
d :	010	012
KL/hl :	4,0	4,5
US-Code :	700X	701X

U_{pm} / rpm
FG - 300000

314 FG **107510** **107512**



ISO No: 500
Cut: 080

23RX

F :	194
d :	012
KL/hl :	4,5
US-Code :	701RX

U_{pm} / rpm
FG - 300000



314 FG **107712**



Trennen von EM, NE, Kronen und Brücken

Cutting of precious and non-precious crowns and bridges

ISO No: 500
Cut: 007

314 FG



F :	137
d :	012
KL/hl :	6,0
US-Code :	1931

U_{pm} / rpm
FG - 300000

314 FG **107912**



ISO No: 500
Cut: 007

316 FG XL

F :	138
d :	010
KL/hl :	2,0
US-Code :	1958

U_{pm} / rpm
FG - 300000

316 FG XL **107810**



Kronentrenner sind zu 2 Stück verpackt.
F = ISO-Figur-Nr. · d = Durchmesser in 1/10 mm
KL = Kopflänge in mm

Crown cutters are packed as 2 pieces.
F = ISO-Shape-No. · d = diameter in 1/10 mm
hl = head length in mm

Kronentrenner Hartmetall / Crown cutters carbide

Trennen von EM und NE sowie extraharten Kompositen.

Cutting of precious and non-precious crowns and bridges as well as extrahard composites.



36 R

U_{pm} / r_{pm}

FG - 300000

ISO No: 500
Cut: 075



F :	137
d :	012
KL/hl :	4,3
US-Code :	1958

107812



314 FG

Trennen von VMK-Kronen sowie NE und EM.

Cutting of PFM, precious and non-precious crowns and bridges.



CB5

U_{pm} / r_{pm}

FG - 300000

ISO No: 500
Cut: 060



F :	196	196
d :	012	014
KL/hl :	3,6	3,6
US-Code :		

109612

109614



314 FG

KFO-Entferner Hartmetall / Orthodontic carbide burs

ISO Nr.: 500 ...

Drehzahl / speed

FG 300000 U_{pm} / r_{pm}

WST/CA 40000 U_{pm} / r_{pm}



Fig.-Nr. / shape no.

Ø 1/10 mm

Verzahnung / cut

KL / hl mm

VE / pu

						
	194		196		272	
	016		012		012	
	006		006		006	
	4,5		4,5		4,5	
	2		2		2	

314 FG

204 WST / CA Typ C 194-0

113016-T

109701

109702

Kronentrenner sind zu 2 Stück verpackt.
F = ISO-Figur-Nr. · d = Durchmesser in 1/10 mm
KL = Kopflänge in mm









Crown cutters are packed as 2 pieces.
F = ISO-Shape-No. · d = diameter in 1/10 mm
hl = head length in mm

Instrumente für die Parodontologie: Perio Diamanten

Instruments for periodontics: perio diamonds

ISO Nr.: 806 205 F 504 superfein / *superfine*
 806 205 F 514 fein / *fine*
 806 205 F 524 mittel / *medium*

Drehzahl / speed
 30' - 60000 Upm / rpm

 831 <table border="0"> <tr><td>F :</td><td>267</td></tr> <tr><td>d :</td><td>012</td></tr> <tr><td>KL/hl :</td><td>7</td></tr> </table>	F :	267	d :	012	KL/hl :	7	 831L <table border="0"> <tr><td>F :</td><td>268</td></tr> <tr><td>d :</td><td>012</td></tr> <tr><td>KL/hl :</td><td>7</td></tr> </table>	F :	268	d :	012	KL/hl :	7	 832 <table border="0"> <tr><td>F :</td><td>258</td></tr> <tr><td>d :</td><td>014</td></tr> <tr><td>KL/hl :</td><td>5</td></tr> </table>	F :	258	d :	014	KL/hl :	5	 832L <table border="0"> <tr><td>F :</td><td>259</td></tr> <tr><td>d :</td><td>014</td></tr> <tr><td>KL/hl :</td><td>5</td></tr> </table>	F :	259	d :	014	KL/hl :	5
F :	267																										
d :	012																										
KL/hl :	7																										
F :	268																										
d :	012																										
KL/hl :	7																										
F :	258																										
d :	014																										
KL/hl :	5																										
F :	259																										
d :	014																										
KL/hl :	5																										
																											





Reduzierstücke und Mandrelle / Reducers and mandrels

Kein Medizinprodukt, nicht für intraoralen Einsatz.
Not a medical device, not for intraoral use.

Kein Medizinprodukt, nicht für intraoralen Einsatz.
Not a medical device, not for intraoral use.

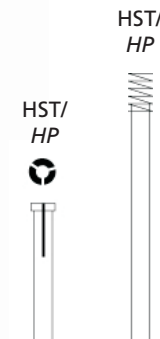
Zur Verwendung von FGs in HST.
For FGs to be used in HP mandrels.

(Ø 2,35 mm >> Ø 1,6 mm)

																				
<table border="0"> <tr><td>Fig.-Nr./shape no.</td><td>612</td><td>602</td></tr> <tr><td>l 1/10 mm</td><td>190</td><td>340</td></tr> <tr><td>VE/pu</td><td>2</td><td>2</td></tr> </table>	Fig.-Nr./shape no.	612	602	l 1/10 mm	190	340	VE/pu	2	2		<table border="0"> <tr><td>Fig.-Nr./shape no.</td><td>604</td><td>604</td></tr> <tr><td>l 1/10 mm</td><td>215</td><td>215</td></tr> <tr><td>VE/pu</td><td>1</td><td>12</td></tr> </table>	Fig.-Nr./shape no.	604	604	l 1/10 mm	215	215	VE/pu	1	12
Fig.-Nr./shape no.	612	602																		
l 1/10 mm	190	340																		
VE/pu	2	2																		
Fig.-Nr./shape no.	604	604																		
l 1/10 mm	215	215																		
VE/pu	1	12																		
																				

Perio Diamanten sind zu 2 Stück verpackt.
 F = ISO-Figur-Nr. · d = Durchmesser in 1/10 mm
 KL = Kopflänge in mm

Perio diamonds are packed as 2 pieces.
 F = ISO-Shape-No. · d = diameter in 1/10 mm
 hl = head length in mm

Mini-Flex

Anwendung:

Für interdentale Feinkorrekturen an Keramik und Kompositen.

Usage:

For interdental corrections of ceramics and composites.



ISO Nr.: 806 ... 504 ...

Drehzahl / speed
3' - 5000 Upm / rpm



Fig.-Nr. / shape no.	355
Ø 1/10 mm	090
KL/hl mm	0,17
VE / pu	1

204 WST / CA

140931

Gewebestanzten / Tissue punches

Anwendung:

Zum Schneiden / Stanzen von Weichgewebe in der lappenlosen Implantologie

Application:

For cutting / punching soft tissue in non-flap implantology

ISO Nr.: 330 204 F 315

Drehzahl / speed
2' - 4000 Upm / rpm



Fig.-Nr. / shape no.	478	478	478
Ø 1/10 mm	035	040	050
VE / pu	1	1	1

204 WST / CA

111240

111250

111260



PreciCut® Soft Tissue Trimmer

Material der Trimmerspitze:
Yttrium-stabilisiertes Zirkonoxid

Cutting edge made of special zirconium oxide stabilised with yttrium

DFS PreciCut®

Präzisions- Gewebeschnneider

DFS PreciCut® Präzisions-Gewebeschnneider werden wie Dentalbohrer in das Handstück einer Turbine eingesetzt. Arbeiten Sie mit hohen Umdrehungszahlen: min. 300000/Min.

Wasserkühlung ist nicht notwendig

Der Präzisions-Gewebeschnneider sollte senkrecht zur Schnittrichtung gehalten werden und mit leichtem Druck geführt werden. Die Schnittführung ist die eines Skalpellchnittes. Nur die Spitze erwärmt sich, was zu einer Koagulation der Gewebeschnittfläche führt und Blutungen fast ganz verhindert, **wenn ohne Kühlwasser gearbeitet wird!**

Der PreciCut® Präzisions-Gewebeschnneider hat eine große Belastbarkeit, ist sehr bruchresistent und stumpft beim Gebrauch nicht ab.

DFS PreciCut®

Precision Soft Tissue Trimmer

DFS PreciCut® Precision Soft-Tissue Trimmers are inserted into the handpiece of a turbine like a dental bur. Please operate at high speed: min. 300000 rpm.

*The cutting efficiency is like a scalpel cut but more precise. **Water cooling is not required.***

*DFS PreciCut® Precision Tissue Trimmers should be applied at a 90° angle to the gingival surface with only light pressure. The tip of the instrument is heating up quickly through tissue friction, the result is an immediate tissue coagulation and minimal bleeding, **provided you work without cooling water!***

The instrument is highly break-resistant and withstands pressure. Tip and surface will not dull.

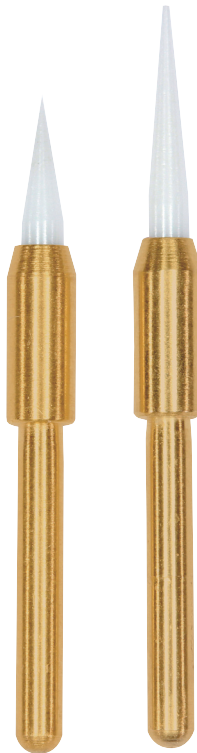

Keramikstruktur
Ceramic structure

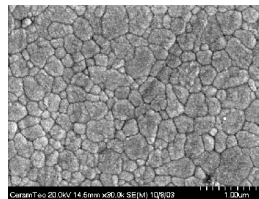

ISO Nr.: 005315...

PreciCut®

PreciCut® Long



Fig.-Nr./shape no.	164	164
Ø 1/10 mm	015	015
KL/hl	5	8
VE / pu	1	1

535000

535100



Orangenreiniger / Orange cleaner

Kein Medizinprodukt, nicht für intraoralen Einsatz.
Not a medical device, not for intraoral use.

UN 1993 Klasse 3 Verpackungsgruppe II
UN 1993 class 3 packing group II

- Inhalt: 500 ml
 - Beseitigt Silikon, Alginat und Zinkoxyd-Eugenol-Pasten sowie Blutreste von den meisten Stoffarten
 - Zur fleckenfreien Pflege von V2A
 - Zum Reinigen von Abdruck-Löffeln
 - Als Luftverbesserer bestens geeignet
- *Content: 500 ml*
 - *Removes silicones, alginates and zinc-oxide-eugenol-pastes as well as remaining blood from most materials*
 - *For a patch-free care of V2A*
 - *For cleaning of impression trays*
 - *Suitable as air-freshener*

27250



Spiegelgriffe / Mirror handles

Spiegelgriffe anatoform

- Kunststoff, sterilisierbar bis 134°C
- Normalgewinde bzw. cone-socket
- Leicht (nur 11,5g)
- Rutschfest, sehr griffig
- Handlich durch anatomisch geformten Griff

Anatomical mirror handles

- *Plastic handle, sterilizable up to 134°C*
- *Standard thread or cone-socket*
- *Light (only 11.5g)*
- *Non-slippery, very handy*
- *Anatomically designed handle*

Kein Medizinprodukt!

Not a medical device!



Normalgewinde / Standard thread:

Cone-socket / Cone socket:

25068

250682

25069

250692

25067

250672

25065

250652

25061

250612

Oraler Scanspray / Scanspray for intraoral use

OKKLEAN®-med

Hochfeiner Spray zur Vorbereitung intraoraler Scans sowie zur Kontrolle der Friktion und Passung dentaler Restaurationen.

Inhalt: 75 ml

OKKLEAN®-med

Superfine spray for intraoral scans and testing of friction and fit of dental restorations.

Content: 75 ml

UN 1950 Klasse 2.1

UN 1950 class 2.1



11147-1med

Weiß / white

Erläuterung der Piktogramme / *Explanation of pictograms*



Nur zum Einmalgebrauch
Single use only



Hersteller
Manufacturer



Chargenbezeichnung
LOT number identification

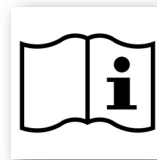

Gebrauchsanweisung beachten
Read instructions for use



Bestellnummer
Order number



Herstellungsdatum
Date of manufacturing



Verwendbar bis
To be used until



Achtung
Attention



Medizinprodukt
Medical device

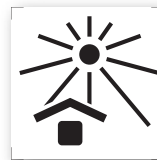

Vor Sonnenlicht schützen
Do not expose to direct sunlight



Trocken aufbewahren
Store in a dry place

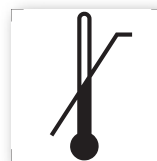

Oberer Temperaturwert
Upper temperature limit



Flüssigkeit und Dampf entzündbar
Flammable liquid and vapour



Sehr giftig für Wasserorganismen mit langfristiger Wirkung
Very toxic to aquatic life with long-lasting effects



Verursacht schwere Verätzungen der Haut und schwere Augenschäden
Causes severe skin burns and eye damage



Achtung!
Attention!

Allgemeine Anwendungs- und Sicherheitshinweise / General application and *safety information*

Allgemeine Anwendungs- und Sicherheitshinweise sowie
Aufbereitungsanweisungen für rotierende
Dentalinstrumente

Diese Informationen finden Sie auf der Webseite der DFS-
DIAMON GmbH: www.dfs-diamon.de. Bei Bedarf können
gedruckte Exemplare in der gewünschten Menge inner-
halb von 7 Werktagen per Post zugesandt werden.

*General application and safety information as well as
reprocessing instructions for rotary dental instruments.*

*This information can be found on the DFS-DIAMON GmbH
website: www.dfs-diamon.de. If required, printed copies
in the desired quantity can be sent by mail within 7 wor-
king days.*

Instrument so tief wie möglich einspannen. (Bei zu kurzem Einspannen besteht Verletzungsgefahr!)

Insert the instrument into the trubine/handpiece as deeply as possible. (Risk of injury if not fully inserted)



Augenschutz benutzen
Wear safety goggles

Index

2ceram Keramikpolierer	48	<i>2ceram polishers for ceramics</i>	48
2comp Kompositpolierer	49	<i>2comp polishers for composites</i>	49
2metal Polierer	48	<i>2metal polishers</i>	48
Amal Cut	63	<i>Amal Cut</i>	63
Bearbeitungssets	41-43	<i>Bur blocks</i>	47
Bohrerstände	47	<i>CA diamonds</i>	28-29
Carboss	54	<i>Carbide bone cutters</i>	52-55
Chirurgie	50-56	<i>Carbide finishers</i>	65-67
Circopol N.	57	<i>Carbide instruments</i>	61-70
Diadoss Fräser	56	<i>Carboss</i>	54
Diafix®-Oral	45	<i>Circopol N.</i>	57
Diafutur®	39-40	<i>Cleaner</i>	73
Diamanten	5-43	<i>Crown cutter Softy-longlife</i>	60
Durocomp Kompositpolierer	49	<i>Crown cutter zirconia</i>	59
ENDO Instrumente	56	<i>Crown cutters carbide</i>	68-69
FG Diamanten	5-27	<i>Depth markers</i>	33
FG Diamanten für Zirkon	58	<i>Diadoss cutters</i>	56
FG Diamanten minimal invasiv	23	<i>Diafix®-Oral</i>	45
FG Piranhas	34-38	<i>Diafutur®</i>	39-40
Finierer	65-67	<i>Diamonds</i>	5-43
Gewebeschneider	72	<i>Durocomp polishers for composites</i>	49
Gewebestanzen	71	<i>Endodontic instruments</i>	56
Handyfix	47	<i>FG diamonds</i>	5-27
Hartmetall Knochenfräser	52-55	<i>FG diamonds for zirconia</i>	58
Hartmetallfinierer	65-67	<i>FG diamonds minimally invasive</i>	23
Hartmetallinstrumente	61-70	<i>FG piranhas</i>	34-38
Kario Cut	61	<i>Finishers</i>	65-67
KFO-Entferner	69	<i>Handyfix</i>	47
Kronentrenner Hartmetall	68-69	<i>Kario Cut</i>	61
Kronentrenner Softy-longlife	60	<i>Kits</i>	41-43
Kronentrenner Zirkon	59	<i>Mandrels</i>	70
Mandrelle	70	<i>Mini-Flex</i>	71
Mini-Flex	71	<i>Mirror handles</i>	73
Orangenreiniger	73	<i>Orange Cleaner</i>	73
Perio Diamanten	70	<i>Orthodontic carbide burs</i>	69
Polierer	44-49	<i>Perio diamonds</i>	70
Präp-Technik	39-40	<i>Polishers</i>	44-49
PreciCut®	72	<i>PreciCut®</i>	72
Prophylaxe Polierer	47	<i>Preparation technique</i>	39-40
Redux	32	<i>Prophylaxis polishers</i>	47
Reduzierstücke	70	<i>Reducers</i>	70
Reiniger	73	<i>Redux</i>	32
RTS	44-46	<i>RTS</i>	44-46
Scanspray intraoral	74	<i>Scanspray for intraoral use</i>	74
Spiegelgriffe	73	<i>Surgery</i>	50-56
Tiefenmarkierer	33	<i>Tissue punches</i>	71
Trepanierer Zirkon	57	<i>Tissue Trimmer</i>	72
Turbo Comp	31	<i>Trepanation instrument zirconia</i>	57
Turbo Laser	30	<i>Turbo Comp</i>	31
Uporal®	45	<i>Turbo Laser</i>	30
WST Diamanten	28-29	<i>Uporal®</i>	45
Zircut®	59	<i>Zirconia tools</i>	57-59
Zirkoninstrumente	57-59	<i>Zircut®</i>	59





DFS Diamon GmbH
Ländenstrasse 1
D-93339 Riedenburg
Phone: +49-9442-9189-0
Fax: +49-9442-9189-37
E-Mail: info@dfs-diamon.de
Web: <https://dfs-diamon.de>